



## Grandstream Networks, Inc.

---

GXV3672\_HD/GXV3672\_FHD v2

Outdoor Day/Night IP Camera



Supplied by Digital Stout Innovation & Trading FZE

This page intentionally left blank

**TABLE OF CONTENTS**  
**GXV3672\_HD/FHD v2 User Manual**

<b>WELCOME.....</b>	<b>5</b>
<b>SAFETY COMPLIANCES .....</b>	<b>6</b>
FCC CAUTION .....	7
RF EXPOSURE INFORMATION (SAR) .....	7
<b>WARRANTY .....</b>	<b>8</b>
<b>CONNECT YOUR GXV3672_HD/FHD V2 .....</b>	<b>9</b>
EQUIPMENT PACKAGE CONTENTS.....	9
CONNECTING THE GXV3672_HD/FHD V2 .....	10
<b>PRODUCT OVERVIEW .....</b>	<b>11</b>
GXV3672_HD/FHD v2 CAMERA.....	11
GXV3672_HD/FHD v2 SPECIFICATIONS .....	12
<b>INSTALLATION GUIDE .....</b>	<b>13</b>
MINIMUM RECOMMENDED COMPUTER SYSTEM REQUIREMENT.....	13
CONFIGURE THE GXV3672_HD/FHD v2 VIA WEB BROWSER .....	13
CONNECT THE CAMERA TO NETWORK WITH DHCP SERVER (RECOMMENDED) .....	14
Windows Platform:.....	14
Apple Platform: .....	16
CONNECT TO THE CAMERA USING STATIC IP .....	18
<b>GXV3672_HD/FHD V2 APPLICATION SCENARIOS .....</b>	<b>19</b>
LAN W/O INTERNET .....	19
LAN WITH INTERNET .....	20
GXV3672_HD/FHD v2 APPLICATION PERIPHERAL CONNECTION.....	21
<b>GXV3672_HD/FHD V2 HOME WEB PAGE .....</b>	<b>23</b>
GXV3672_HD/FHD v2 CONFIGURATION & LANGUAGE PAGE .....	24
<b>BASIC SETTINGS EXPLANATION .....</b>	<b>25</b>
SYSTEM SETTINGS PAGE .....	25
VIDEO & AUDIO SETTING PAGE .....	26
OSD SETTING PAGE.....	28
CMOS SETTINGS PAGE.....	29
NETWORKING SETTING PAGE .....	31
DDNS SETTINGS PAGE .....	32
SIP SETTING PAGE.....	33
STATUS PAGE.....	36
<b>ADVANCED SETTINGS EXPLANATION .....</b>	<b>37</b>
USER MANAGEMENT PAGE.....	37
MAINTENANCE PAGE.....	38
SMTP SETTING PAGE (EMAIL ALARM).....	41
FTP SETTINGS PAGE (UPLOAD ALARM).....	43
PRIVACY MASKS .....	44
ALARM SERVER SETTINGS PAGE (UPLOAD ALARM TO SUPPORTED VMS OR HTTP SERVER) .....	45
TIME LAPSE PHOTOGRAPHY .....	46
MOTION DETECTION CONFIGURATION PAGE (SET ALARM) .....	47
REMOTE ALARM_OUT PEERING WITH GXV3500 DECODER.....	51
CONFIGURE SIP OPEN DOOR PEERING WITH GVR355X NVR .....	55
SYSLOG SETTINGS PAGE (TROUBLESHOOTING HELP).....	61
SOFTWARE UPGRADE .....	62
INSTRUCTIONS FOR LOCAL FIRMWARE UPGRADE USING TFTP SERVER: .....	63
CONFIGURATION FILE DOWNLOAD .....	63
<b>RESTORE FACTORY DEFAULT SETTING.....</b>	<b>64</b>
RESET FROM WEB INTERFACE.....	64

**TABLE OF FIGURES**  
**GXV3672\_HD/FHD v2 USER MANUAL**

FIGURE 1: GXV3672_HD/FHD v2 ILLUSTRATION .....	11
FIGURE 2: WINDOWS “NETWORK” SHOWING GXV3672_HD/FHD v2 AS “OTHER DEVICES” VIA UPNP.....	14
FIGURE 3: “GS_SEARCH” RESULT PAGE OF GXV3672_HD/FHD v2 .....	15
FIGURE 4-1: APPLE SAFARI “BONJOUR” SETTING PAGE TO DISPLAY GXV3672_HD/FHD v2 .....	16
FIGURE 4-2: APPLE SAFARI “BONJOUR” SETTING PAGE TO DISPLAY GXV3672_HD/FHD v2 .....	16
FIGURE 5-1: GXV3672_HD/FHD v2 WORKING IN LAN .....	19
FIGURE 5-2: GXV3672_HD/FHD v2 WORKING WITH GVR355X AND/OR WITH INTERNET .....	20
FIGURE 6: APPLICATION PERIPHERAL CONNECTION FOR GXV3672_HD/FHD v2 .....	21
FIGURE 7: HOME PAGE OF GXV3672_HD/FHD v2 .....	23
FIGURE 8: WEB LANGUAGE SWITCH .....	24
FIGURE 9: SYSTEM SETTINGS PAGE.....	25
FIGURE 10-1: VIDEO & AUDIO SETTINGS PAGE.....	26
FIGURE 10-2: VIDEO & AUDIO SETTINGS PAGE.....	27
FIGURE 11: OSD SETTINGS PAGE.....	28
FIGURE 12: CMOS SETTINGS PAGE.....	29
FIGURE 13: NETWORKING SETTING PAGE.....	31
FIGURE 14: DDNS SETTING PAGE.....	32
FIGURE 15-1: SIP SETTING PAGE.....	33
FIGURE 15-2: SIP SETTING PAGE.....	34
FIGURE 15-3: SIP SETTING PAGE.....	35
FIGURE 16: STATUS PAGE.....	36
FIGURE 17: USER MANAGEMENT PAGE .....	37
FIGURE 18: MAINTENANCE PAGE .....	38
FIGURE 19-1: SMTP SETTING PAGE.....	41
FIGURE 19-2: SMTP SETTING PAGE.....	42
FIGURE 20: FTP SETTING PAGE.....	43
FIGURE 21: PRIVACY MASKS CONFIGURATION PAGE.....	44
FIGURE 22: ALARM HTTP SERVER SETTING PAGE .....	45
FIGURE 23: TIME LAPSE PHOTOGRAPHY CONFIGURATION PAGE.....	46
FIGURE 24-1: MOTION DETECTION CONFIGURATION PAGE.....	47
FIGURE 24-2: MOTION DETECTION CONFIGURATION PAGE.....	48
FIGURE 24-3: MOTION DETECTION SCHEDULE CONFIGURATION PAGE.....	49
FIGURE 24-4: REMOTE ALARM_OUT IP CAMERA CONFIGURATION .....	51
FIGURE 24-5: REMOTE ALARM_OUT PEERING GXV3500 CONFIGURATION .....	52
FIGURE 24-6: REMOTE ALARM_OUT PEERING GXV3500 ACTION OUTPUT DISPLAY .....	53
FIGURE 24-7: PEERING GXV3500 DECODER ALARM_OUT CIRCUIT.....	53
FIGURE 25-1: OPEN DOOR CONFIGURATION .....	57
FIGURE 25-2: ALARM_IN AND ALARM_OUT CONNECTION CIRCUIT SAMPLE FOR GVR355X .....	58
FIGURE 25-3: ALARM_IN AND ALARM_OUT WIRING DIAGRAM FOR GVR355X .....	59
FIGURE 25-4: GVR355X ALARM_OUT CIRCUIT MEASUREMENT .....	60
FIGURE 26: ALARM SERVER SETTING PAGE .....	61
FIGURE 27: FIRMWARE UPGRADE AND PROVISIONING .....	62
FIGURE 28: FACTORY RESET FROM WEB INTERFACE .....	64

**TABLE OF TABLES**  
**GXV3672\_HD/FHD v2 USER MANUAL**

TABLE 1: GXV3672_HD/FHD v2 TECHNICAL SPECIFICATIONS.....	<b>ERROR! BOOKMARK NOT DEFINED.</b>
--	-------------------------------------

## WELCOME

Thank you for purchasing Grandstream's GXV3672\_HD/FHD v2 Outdoor Day/Night High Definition IP Camera, an innovative powerful weatherproof infrared next generation network camera. Its advanced ISP (Image Sensor Processor) powered with state-of-the-art auto-exposure/auto-white-balance algorithm and a high quality lens, ensures high fidelity video quality that matches digital still camera color grade in a wide range of light environments. It features cutting edge H.264 real-time video compression with excellent image clarity (720p for GXV3672HD; 1080p for GXV3672\_FHD) and color fidelity, industry leading SIP/VoIP for video streaming to smartphones and video phones, integrated PoE, IR-CUT (mechanical) for day or night mod, and advanced security protection using strong encryption.

The GXV3672\_HD/FHD v2 can be managed with GSurf V2 Pro (Grandstream's intuitive FREE video management software that controls up to 72 cameras simultaneously), or grouped with GVR355X Grandstream Network Video Recorder (NVR) via plug-n-play, as well as other ONVIF compliant video management systems. It also offers an advanced and flexible HTTP API and an SDK for easy integration with other surveillance systems. .



Designed for both indoor and outdoor environment, the GXV3672\_HD/FHD v2 Day/Night HD IP camera is a new addition to the popular GXV3XXX series IP surveillance product family. It ensures ease of use, integration and deployment, with multilingual graphical user interface, provides powerful solution to professional surveillance applications.

Ideal application scenes for GXV3672\_HD/FHD v2 are like store, parking lot, elevator, office, crossing road point, and other indoor or outdoor related environments.

This manual will help you to learn how to operate and manage your GXV3672\_HD/FHD v2 Outdoor Day/Night HD IP camera and make the best use of it.

## SAFETY COMPLIANCES

These instructions are intended to assist users to safely operate the GXV3672\_HD/FHD V2, avoid dangerous situations or damage the device.

	
<b>Warning:</b> May cause serious injury or death if any of the warnings below are neglected.	<b>Caution:</b> Equipment may be damaged if any of the following caution messages are neglected.



### Warning:

Input voltage should meet both the SELV (Safety Extra Low Voltage) and the Limited Power Source with DC 12V according to the IEC60950-1 standard. Please refer to the technical specifications for more details. Do not use a third-party power adapter or power cord. When the device installed on the wall or ceiling, make sure that it is firmly attached.



### Caution:

- Make sure that the power supply voltage is correct before using the camera.
- Do not drop the device or expose it to physical shock.
- Do not expose the device to temperatures outside the range of -20 °C to 45°C when the device is in operation.
- Do not expose the device to damp/wet conditions or high electromagnetism radiation.
- To avoid heat accumulation, make sure that your operating environment has proper ventilation.
- Do not damage the warranty sticker.

A few parts (e.g. electrolytic capacitor) of the equipment shall be replaced regularly according to their average lifetime. The average lifetime varies from the differences between operating environments and usage history. Regular maintenance checks are recommended for all users. Please contact your dealer for more details.

## FCC CAUTION

Any Changes or modifications not expressly approved by the party responsible for compliance could void the user's authority to operate the equipment. This device complies with part 15 of the FCC Rules. Operation is subject to the following two conditions:

- 1) This device may not cause harmful interference.
- 2) This device must accept any interference received, including interference that may cause undesired operation.

Note: This equipment has been tested and found to comply with the limits for a Class B digital device, pursuant to part 15 of the FCC Rules.

These limits are designed to provide reasonable protection against harmful interference in a residential installation. This equipment generates uses and can radiate radio frequency energy and, if not installed and used in accordance with the instructions, may cause harmful interference to radio communications. However, there is no guarantee that interference will not occur in a particular installation. If this equipment does cause harmful interference to radio or television reception, which can be determined by turning the equipment off and on, the user is encouraged to try to correct the interference by one or more of the following measures:

- Reorient or relocate the receiving antenna.
- Increase the separation between the equipment and receiver.
- Connect the equipment into an outlet on a circuit different from that to which the receiver is connected.
- Consult the dealer or an experienced radio/TV technician for help.

## RF EXPOSURE INFORMATION (SAR)

This device is designed and manufactured not to be exceeded the emission limits for exposure to radio frequency RF energy set by the Federal Communications Commission of the United States. The exposure standard for wireless devices employing a unit of measurement is known as the Specific Absorption Rate (SAR), and the SAR limit set by FCC is 1.6 W/kg.

This device is complied with SAR for general population/uncontrolled exposure limits in ANSI/IEEE C95.1-1992, and has been tested in accordance with the measurement methods and procedures specified in OET Bulletin 65 Supplement C. This device has been tested, and meets the FCC RF exposure guidelines when tested with the device directly contacted to the body. RF exposure compliance with anybody-worn accessory, which contains metal, was not tested and certified, and uses such body-worn accessory, should be avoided.

Changes or modifications not expressly approved by the party responsible for compliance could void the user's authority to operate the equipment.

Hereby, Grandstream declares that this device is in compliance with the essential requirements and other relevant provisions of Directive 1999/5/EC.

## WARRANTY

If you purchased your GXV3672\_HD/FHD v2 from a reseller, please contact the company where you purchased the device for replacement, repair or refund.

If the device was purchased directly from Grandstream, please contact our technical support team for a RMA (Return Materials Authorization) number before the product is returned.

Grandstream reserves the right to remedy warranty policy without prior notification.



### Caution:

*Changes or modifications to this product not expressly approved by Grandstream, or operation of this product in any way other than as detailed by this User Manual, could void your manufacturer warranty. Please do not use a different power adaptor with the GXV3672\_HD/FHD v2 as it may cause damage to the products and void the manufacturer warranty.*

- This document is subject to change without notice. The latest electronic version of this user manual is available for download at:

[http://www.grandstream.com/sites/default/files/Resources/GXV3672hd\\_fhd\\_v2\\_usermanual\\_english.pdf](http://www.grandstream.com/sites/default/files/Resources/GXV3672hd_fhd_v2_usermanual_english.pdf)

*Reproduction or transmittal of the entire or any part, in any form or by any means, electronic or print, for any purpose is not permitted without the express written permission of Grandstream Networks, Inc.*



## CONNECT YOUR GXV3672\_HD/FHD v2

### Equipment Package Contents

The GXV3672\_HD/FHD v2 package contains:

- GXV3672\_HD/FHD v2 IP Camera
- 12V DC Universal Power Adaptor
- Ethernet Cable
- Hex Key and 3 Screws and Wall Anchors
- Quick Installation Guide and GNU GPL license



1 x GXV3672\_HD/FHD



1 x 12V Power Supply

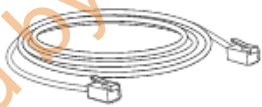

1 x Ethernet Cable



3 x Wall Anchors



3 x Screw



1 x Hex Key

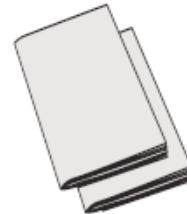

1 x Quick Start Guide  
1 x GPL License

## Connecting the GXV3672\_HD/FHD v2

Using the Power Adapter as power supply

- Connect the RJ-45 Ethernet cable to the NETWORK port of the GXV3672\_HD/FHD
- Connect the other end of the RJ-45 cable to your network (switch or router or PC)
- Connect the power supply to the DC 12V power jack on the back of the GXV3672\_HD/FHD

Using PoE as power supply

- Connect the RJ-45 Ethernet cable to the NETWORK port of GXV3672\_HD/FHD v2
- Connect the other end of the RJ-45 cable to your PoE switch.
- PoE injector can be used if PoE switch is not available.

Please refer to following connection diagram to hook up the camera.

Refer to the illustration below when following the instructions on the next page.

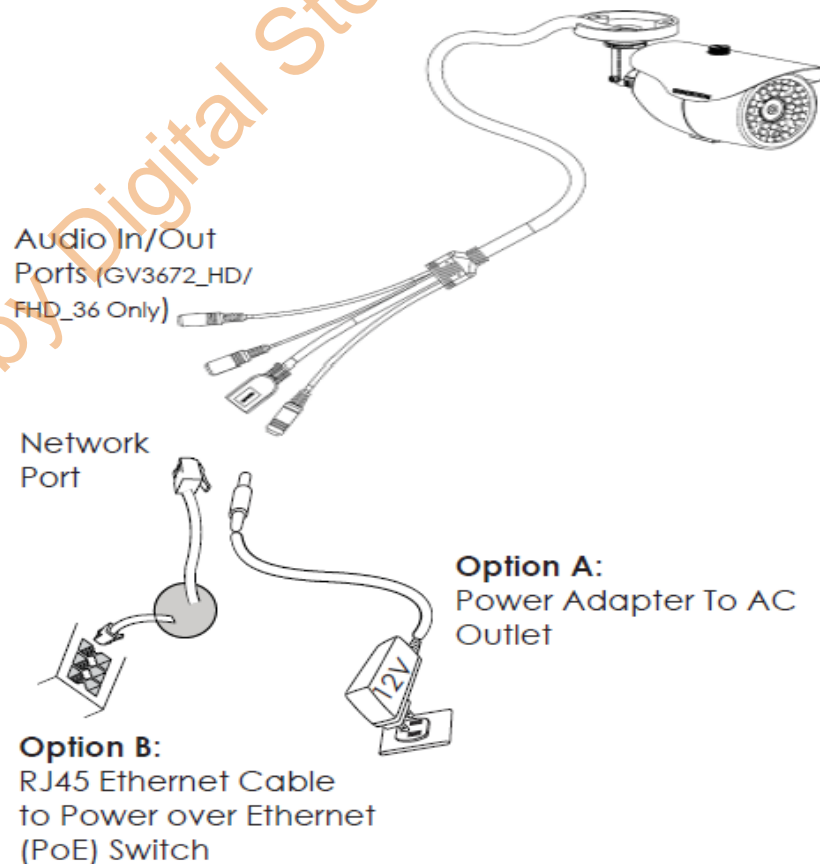

**NOTE:** Choose Option A if using the power supply; or choose Option B if using a Power over Ethernet (PoE) switch.

## PRODUCT OVERVIEW

### GXV3672\_HD/FHD v2 Camera

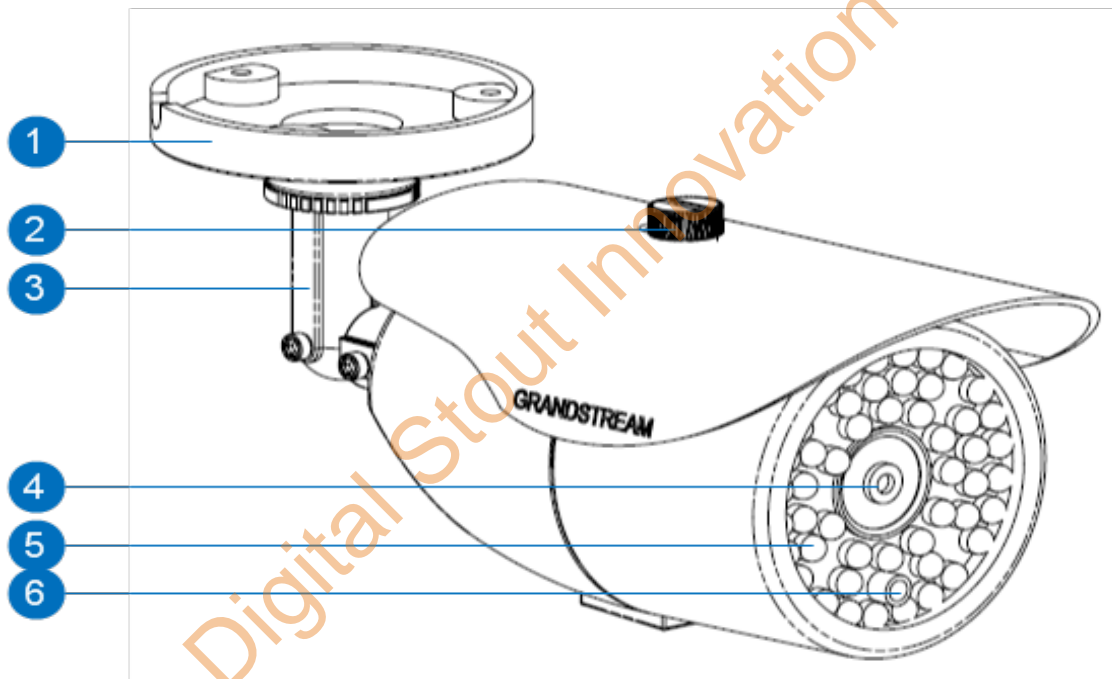

Figure 1: GXV3672\_HD/FHD v2 Illustration

- |                                   |   |
|-----------------------------------|---|
| 1. <b>Mounting Plate</b>          | GXV3672_HD/FHD v2 Mounting Plate                        |
| 2. <b>Top Shield Cover/Screw</b>  | Top metal cover (shielding direct light and rain, etc.) |
| 3. <b>Adjustable Wire Shield</b>  | Adjustable cylinder for wiring shield                   |
| 4. <b>Lens</b>                    | 1/3" CMOS (1.2M for HD/3.1M for FHD) and Lens           |
| 5. <b>IR Light Array</b>          | Infrared Light Array                                    |
| 6. <b>Light Sensor for IR-Cut</b> | Light Sensor for mechanical IR-Cut switching            |

**GXV3672\_HD/FHD v2 Specifications**

Model v2	GXV3672_HD_36 GXV3672_HD	GXV3672_FHD_36 GXV3672_FHD
<b>Video Compression</b>	H.264, MJPEG	
<b>Image Sensor Resolution</b>	1/3", 1.2 Megapixel Progressive Scan CMOS, 1280H x 960V	1/3", 3.1 Megapixel Progressive Scan CMOS, 2048H x 1536V
<b>Image Sensor Sensitivity</b>	Day/Night Mode (exceptional low noise level, low light sensitivity) Shutter: 1/10000 – 1/30 second	
<b>Focal Length</b>	3.6mm: GXV3672_HD_36 & GXV3672_FHD_36 8.0mm: GXV3672_HD & GXV3672_FHD	
<b>Aperture</b>	F1.8	
<b>Field Angle (FOV)</b>	3.6mm: 100.2°(D) x 77°(H) x 54°(V) 8.0mm: 46°(D) x 36°(H) x 26.5°(V)	
<b>IR Cut Filter</b>	Yes, Mechanical	
<b>Day &amp; Night Mode</b>	3.6mm: IR LED covering up to 10 meter 8.0mm: IR LED covering up to 30 meter	
<b>Minimum Illumination</b>	0.05 Lux; 0 Lux with IR LED On	
<b>Responsivity</b>	5.48V/Lux-sec (550nm)	1.9V/Lux-sec (550nm)
<b>Supported Maximum Video Resolution and Frame Rate</b>	1280x960 (25fps) 1280x720 (30fps)	2048x1536 (15fps) 1920x1080 (30fps)
<b>Video Bit Rate</b>	32 Kbps ~ 8 Mbps, Multi-rate for Preview & Recording	
<b>Audio Input</b>	Line-In, 1500Ω, 0.1Vrms ~ 0.707Vrms	
<b>Audio Output</b>	Line-Out, 600Ω, 0.707Vrms	
<b>Audio Compression</b>	G.711u/a (PCMU, PCMA)	
<b>Embedded Analytics</b>	Motion Detection (up to 16 target areas)	
<b>Pre-/post-alarm Recording</b>	Yes, 8MB	Yes, 3MB
<b>WDR (Wide Dynamic Range)</b>	No	Yes (100dB)
<b>Snapshots</b>	Triggered upon events, Send via email/FTP	
<b>Network Protocol</b>	TCP/UDP/IP, RTP/RTCP, RTSP, DHCP, DDNS, HTTP, HTTPS, SMTP, FTP, NTP	
<b>SIP/VoIP Support</b>	Yes	
<b>Time-Lapse Photography</b>	Yes	
<b>Privacy Mask Support</b>	Yes, 4 Zones	
<b>Power over Ethernet (PoE)</b>	IEEE 802.3af, Class 0	
<b>External Cable Connection</b>	Network: RJ45, 10M/100M Auto-Sensing 3.5mm Line-In 3.5mm Line-Out Power Input	
<b>Dimensions (D x L)</b>	94mm (D) x 230mm (L)	
<b>Weight</b>	0.52kg	
<b>Temperature / Humidity</b>	Operating: -20°C ~ 45°C (-4°F ~ 113°F), 10 ~ 90%, RH(non-condensing) Storage: -30°C ~ 60°C (-22°F ~ 140°F)	
<b>Power Adapter</b>	Output: 12VDC/1A; Input: 100–240VAC, 50–60Hz	
<b>Casing</b>	IP66 Compliant Weather-Proof Metal Case	
<b>Compliance</b>	FCC Part 15, Subpart B Class B; EN 55022 Class B, EN 61000-3-2, EN 61000-3-3, EN 55024, EN 60950-1; C-tick AS/NZS CISPR 22, IP66	

**Table 1: GXV3672\_HD/FHD v2 Technical Specifications**

## INSTALLATION GUIDE

### Minimum Recommended Computer System Requirement

To install GXV3672\_HD/FHD v2, you will have a computer, PC recommend.  
The minimum recommended PC system requirement listed below:

- Windows XP, Windows Vista, Windows 7 and Windows 8
- CPU: Intel Pentium 4 or higher, 2 GHz
- RAM: 2 GB (4 GB recommended for larger systems)
- Support for DirectX 8.0 and above.

### Configure the GXV3672\_HD/FHD v2 via Web Browser

The GXV3672\_HD/FHD V2 has embedded Web server to respond to HTTP GET/POST requests. Embedded HTML pages allow user to configure the IP camera through Microsoft Internet Explorer (7.0 or above), Firefox, Chrome (plug-in from Grandstream required).

- Download WebControl Plug-in from Grandstream website:  
[http://www.grandstream.com/sites/default/files/Resources/GSurf\\_Pro\\_V2\\_1.0.3.13.zip](http://www.grandstream.com/sites/default/files/Resources/GSurf_Pro_V2_1.0.3.13.zip)

For Apple platform OS-X, only MJPEG video coded supported currently.

### **NOTE:**

- *Please temporarily disable Antivirus or Internet Security Software when download and install the Grandstream WebControl Plug-in for Firefox/Chrome or “GSViewerX.cab” for Microsoft Internet Explorer. Please close Browser to install the downloaded Plug-in or Active-X.*
- *Please trust and install the file downloaded if prompted by the Antivirus or Security software.*

## Connect the Camera to network with DHCP server (Recommended)

The GXV3672\_HD/FHD v2 by default enabled as DHCP client, it will automatically get IP address from the network with DHCP server running.

### WINDOWS PLATFORM:

There are two ways for Windows user to get access to the IP Camera easily:

#### A. UPnP

By default, the GXV3672\_HD/FHD v2 has the UPnP feature turned ON. For customers using Window network with UPnP turned on (most SOHO router support UPnP), it is very easy to access the IP camera:

- Find the “Network” icon  at Windows Desktop.
- Click the icon to get into the “Network” and the IP cameras will list as “Other Devices” shown like below. Refresh the pages if nothing displayed. Otherwise, the UPnP may not active in the network.

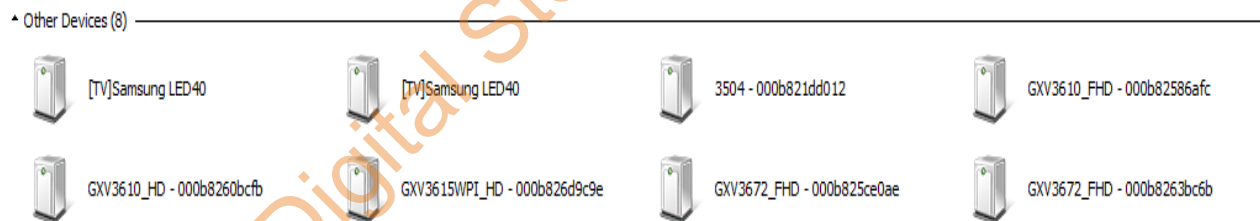
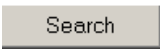

**Figure 2: Windows “Network” showing GXV3672\_HD/FHD v2 as “Other Devices” via UPnP**

- Click the displayed icon of related IP camera, the default browser (e.g.: Firefox or Chrome) will open and connect directly to the camera’s webpage, prompt message will display asking for plug-in installation.
- Disable security or antivirus software, download the plug-in, close browser and install the plug-in, open the browser again, the embedded video will be displayed if clicking the icon of the related IP Camera.

#### B. “GS Search” Utility Tool

User can know the IP address assigned to the camera from DHCP server log or using the Grandstream GS\_Search tool. Following is the instruction for using “GS\_Search” utility tool:

1. Download the GS\_Search tool from Grandstream website:  
[http://www.grandstream.com/sites/default/files/Resources/GS\\_Search.zip](http://www.grandstream.com/sites/default/files/Resources/GS_Search.zip)
2. Run the Grandstream GS\_Search tool by double click the unzipped “GS\_Search.exe”.
3. Click on the  button to begin device detection
4. The detected devices will appear in the output field like below

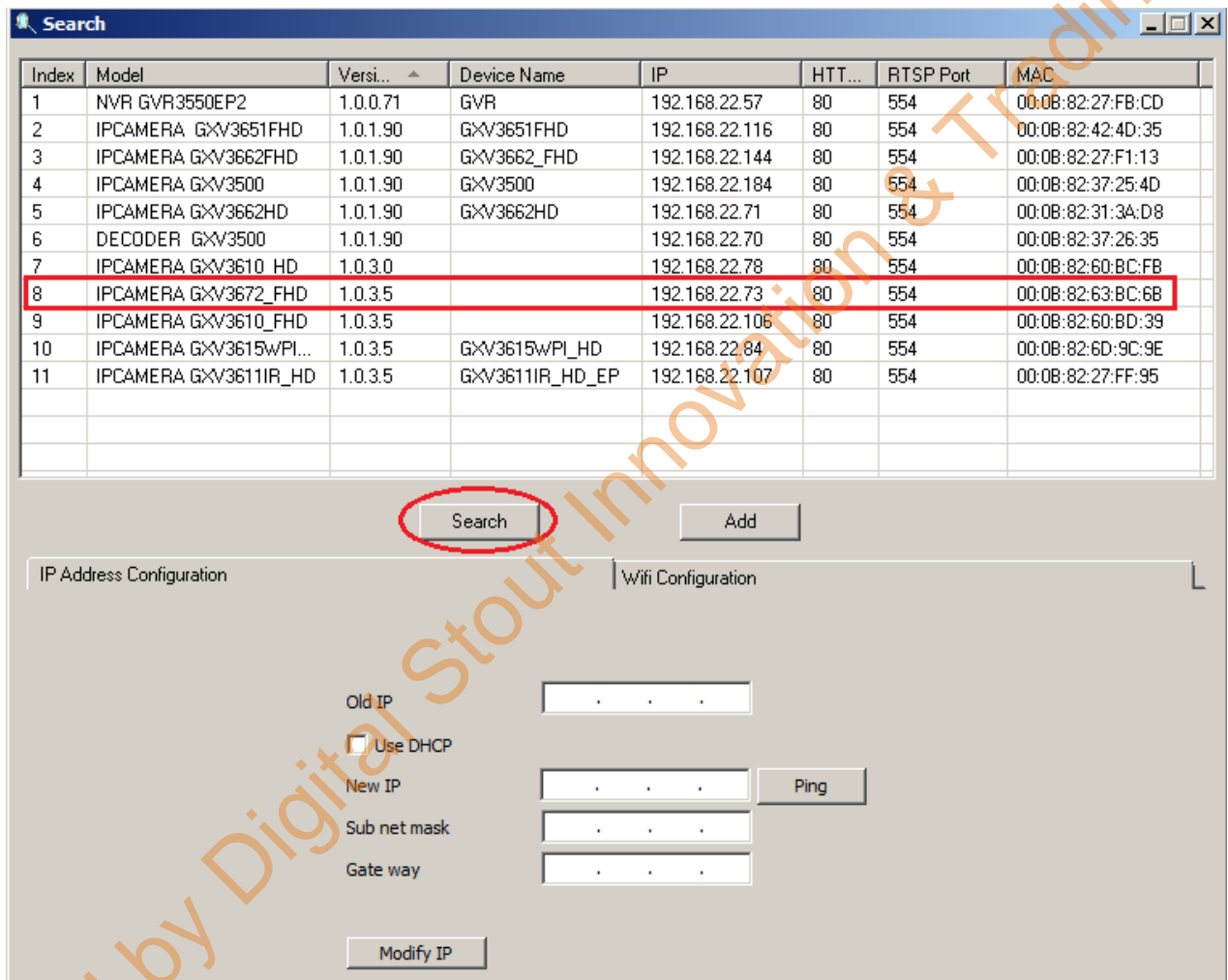

Index	Model	Versi...	Device Name	IP	HTT...	RTSP Port	MAC
1	NVR GVR3550EP2	1.0.0.71	GVR	192.168.22.57	80	554	00:0B:82:27:FB:CD
2	IPCAMERA GXV3651FHD	1.0.1.90	GXV3651FHD	192.168.22.116	80	554	00:0B:82:42:4D:35
3	IPCAMERA GXV3662FHD	1.0.1.90	GXV3662_FHD	192.168.22.144	80	554	00:0B:82:27:F1:13
4	IPCAMERA GXV3500	1.0.1.90	GXV3500	192.168.22.184	80	554	00:0B:82:37:25:4D
5	IPCAMERA GXV3662HD	1.0.1.90	GXV3662HD	192.168.22.71	80	554	00:0B:82:31:3A:D8
6	DECODER GXV3500	1.0.1.90		192.168.22.70	80	554	00:0B:82:37:26:35
7	IPCAMERA GXV3610_HD	1.0.3.0		192.168.22.78	80	554	00:0B:82:60:BC:FB
8	IPCAMERA GXV3672_FHD	1.0.3.5		192.168.22.73	80	554	00:0B:82:63:BC:6B
9	IPCAMERA GXV3610_FHD	1.0.3.5		192.168.22.106	80	554	00:0B:82:60:BD:39
10	IPCAMERA GXV3615WPI...	1.0.3.5	GXV3615WPI_HD	192.168.22.84	80	554	00:0B:82:6D:9C:9E
11	IPCAMERA GXV3611IR_HD	1.0.3.5	GXV3611IR_HD_EP	192.168.22.107	80	554	00:0B:82:27:FF:95

Search Add

IP Address Configuration | Wifi Configuration

Old IP

Use DHCP

New IP  Ping

Sub net mask

Gate way

Modify IP

**Figure 3: “GS\_Search” Result Page of GXV3672\_HD/FHD v2**

5. Double click the column of the detected camera, the browser will automatically open and link to the device IP and the web configuration page.
6. The browser will ask for plug-in or ActiveX if not installed, otherwise it will get to Home page and start to show the video captured by the camera (by default the camera enabled anonymous access)
7. Click “Configuration” icon, the browser will ask credentials to authorize configuration.
8. Enter the administrator user name and password to access the Web Configuration Interface, the default user name and password are both set to **admin**.
9. In step 6, browser will indicate that “This website wants to install the following add-on: GSVIEWERX.cab from Grandstream Networks Inc.” Please allow the installation.
10. The plug-in can be download here:

[http://www.grandstream.com/sites/default/files/Resources/GSurf\\_Pro\\_V2\\_1.0.3.13.zip](http://www.grandstream.com/sites/default/files/Resources/GSurf_Pro_V2_1.0.3.13.zip)

## APPLE PLATFORM:

For Apple users, please turn on Bonjour of Safari to find and access the GXV3672\_HD/FHD v2.

- 1) Open Safari, select “Advanced” to open the Advanced Setting.
- 2) Click “Include Bonjour in the Bookmarks menu” and “Include Bonjour in the Favorites bar” then close the setting page and back to Safari.

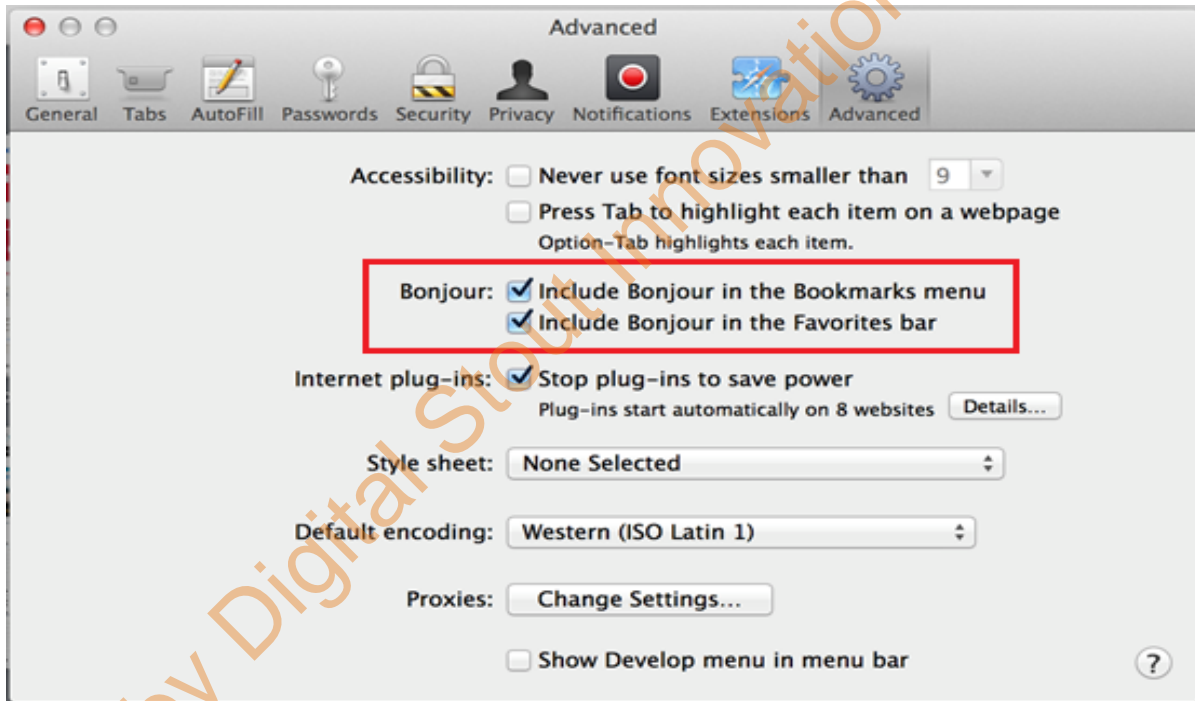

Figure 4-1: Apple Safari “Bonjour” Setting page to display GXV3672\_HD/FHD V2

- 3) Bonjour will now display embedded at Safari. Select “Bonjour” pull-down menu and select “Webpages”, the related IP Camera like GXV3672\_HD/FHD v2 will be there.

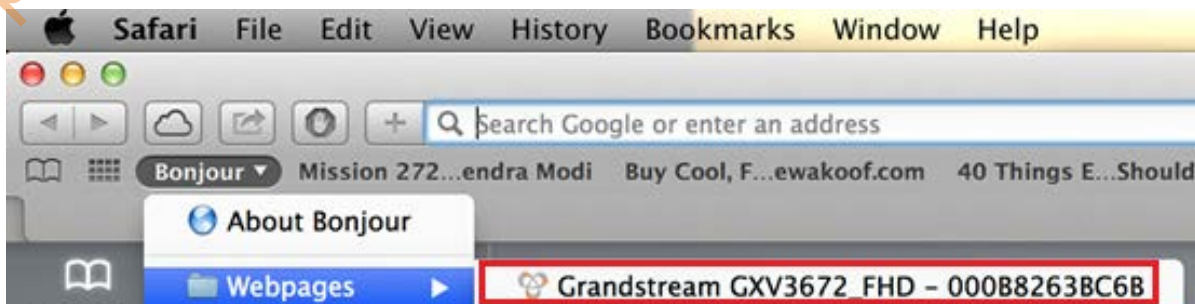

Figure 4-2: Apple Safari “Bonjour” Setting page to display GXV3672\_HD/FHD v2

- 4) Click the displayed camera to access to the configuration page of the camera.



- 5) To see the video, user has to change the video codec from default H.264 to MJPEG, and type in following to URL:

[http://IP\\_Address\\_Camera:Port/mjpeg/mjpegX.html](http://IP_Address_Camera:Port/mjpeg/mjpegX.html)

(X: 0, 4 represent 1<sup>st</sup>, 2<sup>nd</sup> stream, Default Port: 80)



**NOTE:**

- The instruction given here based on Safari/OS-X, other Apple platform like iOS (iPhone/iPad) can use similar method.



- iPhone/iPad (iOS) users are recommended to use Applications in Apple Store.
- Free or Paid applications from Apple Store like “IP Cam Viewer” are suggested and verified working with Grandstream IP Cameras like GXV3672\_HD/FHD v2.
- Apple Store applications like “IP Cam Viewer” will support H.264 video codec.

## Connect to the Camera using Static IP

If no DHCP server in the network, or the camera does not get IP from DHCP server, user can connect the camera to a computer directly, using static IP to configure the camera.

The default IP, if no DHCP server; or DHCP offer time out (3 minutes), is **192.168.1.168**

1. Connect the computer RJ-45 via an Ethernet cable directly to the IP camera GXV3672\_HD/FHD v2.
2. Configure the computer using Static IP: 192.168.1.XXX (1<XXX<255, but NOT 168) and configure the “Subnet mask” to “255.255.255.0”. Leave the “Default Gateway” to “Blank” like below:

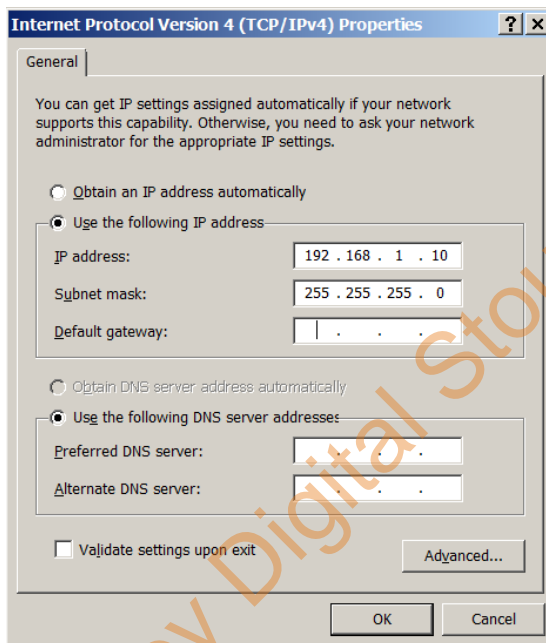

3. Power on the GXV3672\_HD/FHD v2.
4. Start the IE or Firefox browser when the network connection is up.
5. Enter 192.168.1.168 in the address bar of the browser.
6. The browser will ask for plug-in or ActiveX if not installed, otherwise it will get to Home page and start to show the video captured by the camera (by default the camera enabled anonymous access)
7. Click “Configuration”, the browser will ask credentials to authorize configuration.
8. Enter the administrator user name and password to access the Web Configuration Interface, the default user name and password are both set to **admin**.
9. In step 6, IE will indicate that “This website wants to install the following add-on: GSViewerX.cab from Grandstream Networks Inc.”, allow the installation.
10. Firefox user need to download and install the plug-in to see the video, the plug-in is here:
11. [http://www.grandstream.com/sites/default/files/Resources/GSurf\\_Pro\\_V2\\_1.0.3.13.zip](http://www.grandstream.com/sites/default/files/Resources/GSurf_Pro_V2_1.0.3.13.zip)

### **NOTE:**

- Please temporarily disable Antivirus or Internet Security Software when download and install the Grandstream Firefox plug-in for video or “GSViewerX.cab” for Microsoft Internet Explorer.

## GXV3672\_HD/FHD v2 APPLICATION SCENARIOS

GXV3672\_HD/FHD v2 is very versatile infrared IP Camera, it can be used in a lot of scenarios.

### LAN w/o Internet

For multi-room or a bigger space, multiple GXV3672\_HD/FHD v2 might be required. User can establish a local area network using PoE switch.

If remote access required, a router with internet access may add in.

Equipment List:

- 1) Several GXV3672\_HD/FHD v2
- 2) Ethernet cables
- 3) Switch (Static IP required to configure to IP Cameras)
- 4) PoE Switch (Optional, better solution)

If remote access to the cameras required to view the LIVE video stream, then broadband Internet is required and more equipment required:

- 5) Router (if DHCP configured than static IP is not required although still recommended)
- 6) Broadband Internet Access (FiOS, Cable or DSL)
- 7) iPhone or Android phone. (Application like "IP Cam Viewer")

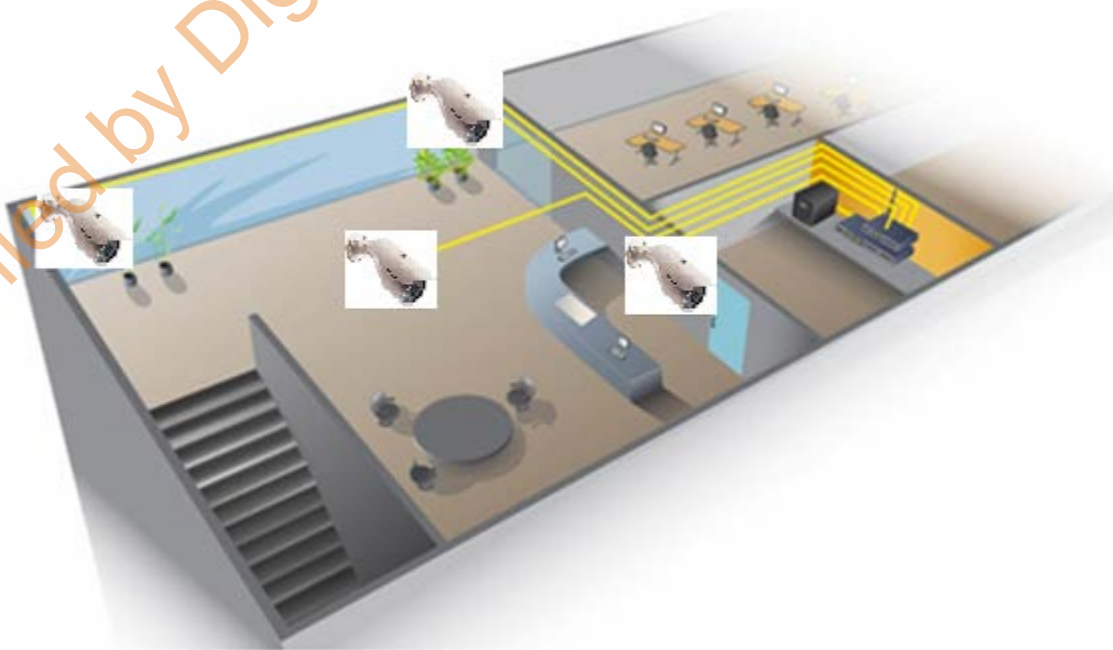

**Figure 5-1: GXV3672\_HD/FHD v2 Working in LAN**

## LAN with Internet

For multi-room or a bigger space, with Internet access and local video recording required, following list is recommended:

### Equipment List:

- 1) Several GXV3672\_HD/FHD v2
- 2) GVR355X NVR
- 3) Ethernet cables
- 4) Switch (PoE Switch recommended)
- 5) Router
- 6) Broadband Internet Access (FiOS, Cable or DSL)
- 7) iPhone or Android phone. (Application like “IP Cam Viewer”)
- 8) GSurf\_Pro V2 Remote Access (Optional)

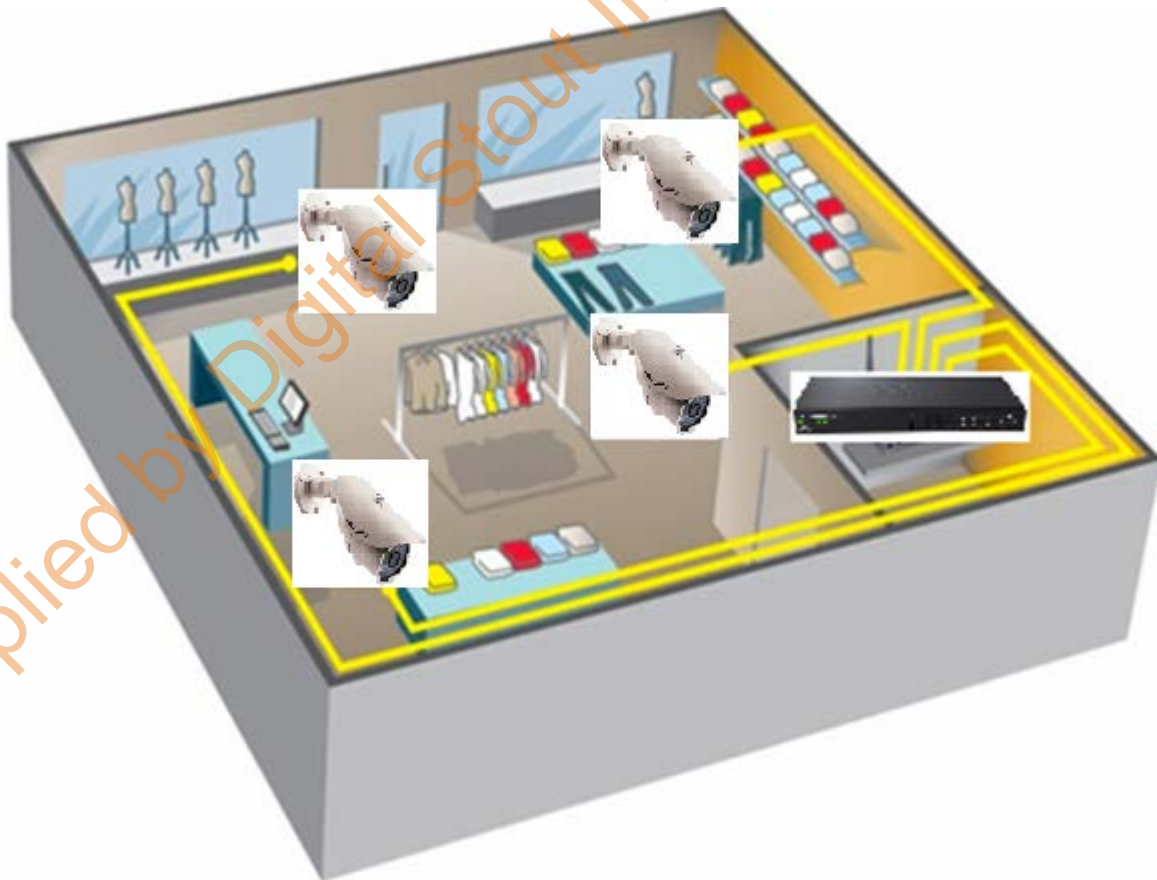

**Figure 5-2: GXV3672\_HD/FHD v2 Working with GVR355X and/or with Internet**

## GXV3672\_HD/FHD v2 Application Peripheral Connection

Below is the illustration of GXV3672\_HD/FHD v2 peripheral connections for related application.



**Figure 6: Application Peripheral Connection for GXV3672\_HD/FHD v2**

**NOTE:**

- Audio Output (Amplified Speaker) using 3.5mm interface and must match below impedance parameter:

<b>Audio Input</b>	3.5mm Line-In, 1500Ω, 0.1Vrms ~ 0.707Vrms
<b>Audio Output</b>	3.5mm Line-Out, 600Ω, 0.707Vrms

- Grandstream Video Phone can work with GXV3672\_HD/FHD v2 via either Peer IP (LAN) or SIP extension (WAN). Peer to Peer (or Direct IP) works only at LAN using static IP; SIP extension requires related SIP server/proxy provided and configured.

Supplied by Digital Stout Innovation & Trading FZE

This page intentionally left blank

## GXV3672\_HD/FHD v2 HOME WEB PAGE

The Home Page of GXV3672\_HD/FHD v2:

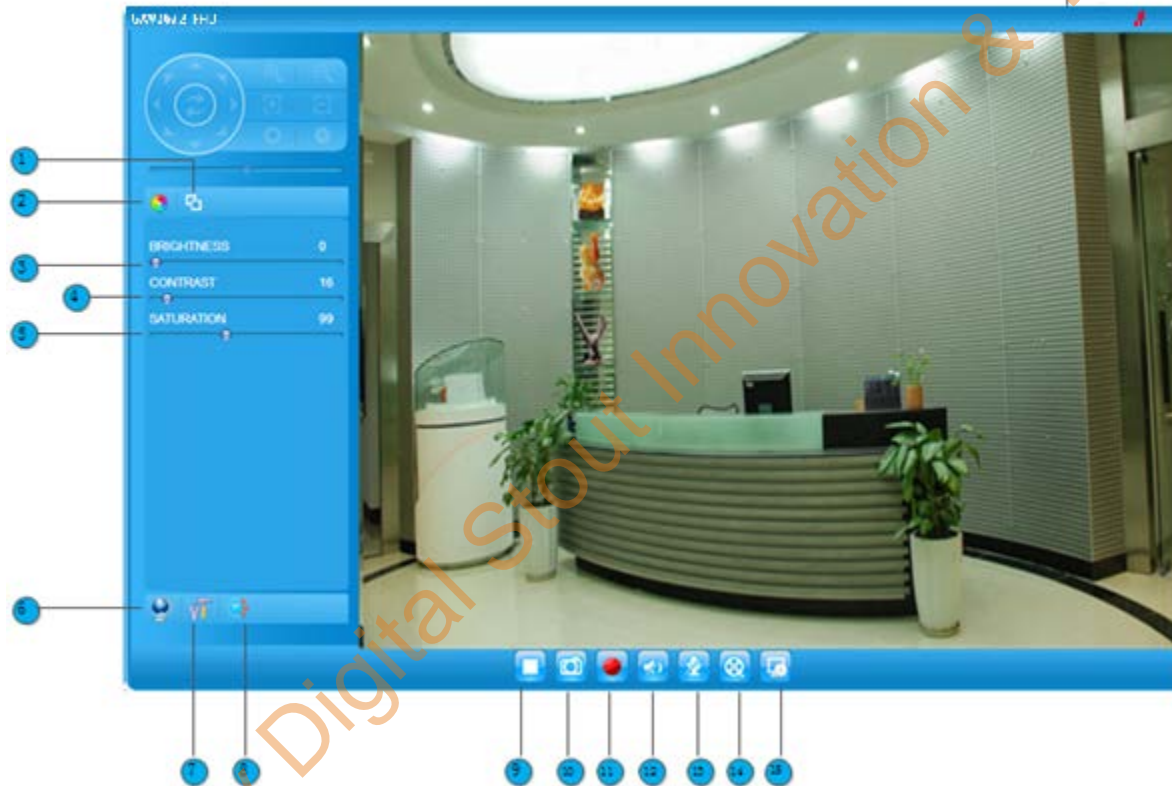

Figure 7: Home Page of GXV3672\_HD/FHD v2

- |   |   |
|---|---|
| <ol style="list-style-type: none"> <li>1. <b>Real Size/Window Size icon:</b></li> <li>2. <b>ZOOM:</b></li> <li>3. <b>BRIGHTNESS bar:</b></li> <li>4. <b>CONTRAST bar:</b></li> <li>5. <b>SATURATION bar:</b></li> <li>6. <b>Language icon</b></li> <li>7. <b>Configuration icon:</b></li> <li>8. <b>Default Video Parameter icon:</b></li> <li>9. <b>Stop/Play Video icon:</b></li> <li>10. <b>Capture (Snapshot) icon</b></li> <li>11. <b>Record icon:</b></li> <li>12. <b>Listen On/Off icon:</b></li> <li>13. <b>Talk On/Off icon:</b></li> <li>14. <b>Playback:</b></li> <li>15. <b>Local Configuration:</b></li> <li>16. <b>Motion Detection Alarm Indicator:</b></li> </ol> | <p>Click to switch between real resolution size and embedded window size video.</p> <p>Zoom in or Zoom out during ePTZ operation (Default Not Applicable).</p> <p>Adjust the image or video brightness.</p> <p>Adjust the image or video contrast.</p> <p>Adjust the image or video saturation.</p> <p>Click to switch webpage language.<br/>(Current support: Chinese, English and Russian)</p> <p>Click to enter "Configuration Page" to configure the parameters of GXV3672_HD/FHD (Administration privilege required).</p> <p>Click to reset video parameters (Brightness, Contrast, Saturation) to default.</p> <p>Click to Stop and Play the embedded live video.</p> <p>Click to capture and save a snapshot of current displayed video frame.<br/>Default directory: C:\Capture, using date stamp as folder name.</p> <p>Click to Start/Stop record of current video stream into a file.<br/>Default directory: C:\Record</p> <p>Toggle to listen/stop audio from the camera's microphone</p> <p>Toggle to talk to camera's speaker (computer microphone required)</p> <p>Click to playback the recorded video file.</p> <p>Click to configure the file path of snapshot and recorded video files.<br/>Also adjust the video delay or smoothness.</p> <p>If (configured) motion detection alarm triggered, the indicator will flash in <b>red</b>.<br/>Click the indicator icon to turn off the alarm indication.</p> |
|---|---|

## GXV3672\_HD/FHD v2 Configuration & Language Page

- When click the “Configuration” tab, web page will link to page to configure the related parameters of the GXV3672\_HD/FHD.
- There are two big categories of settings: Basic Settings and Advanced Settings. Details will be illustrated in the later Chapter.
- When click the “Language” tab, supported languages will be displayed in Figure 2. Click to select the related webpage display language.



**Figure 8: Web Language Switch**

- Currently firmware only support: English (default), Simplified Chinese and Russian.



## BASIC SETTINGS EXPLANATION

### System Settings Page

This page allow user to configure the system settings of GXV3672\_HD/FHD v2.



Figure 9: System Settings Page

- **Current System Time:**
  - *Sync with PC:* Display time current system is running at
  - *Set Manually:* Click to synchronize current time with computer. Click to manually set the current time and date.
- **Time Zone:**
  - Enable DST: Select from pull down menu the time zone unit located
  - NTP: Configure Day Light Saving Time
- **Device Name:** Enable and configure NTP server and update interval. Set the name of the camera which will be shown in the result of “Search Tool” of VMS program.

### NOTE:

- **Save** button has to be clicked to save all the changes made to the device.

## Video & Audio Setting Page

This page allows user to configure the video and audio related settings.

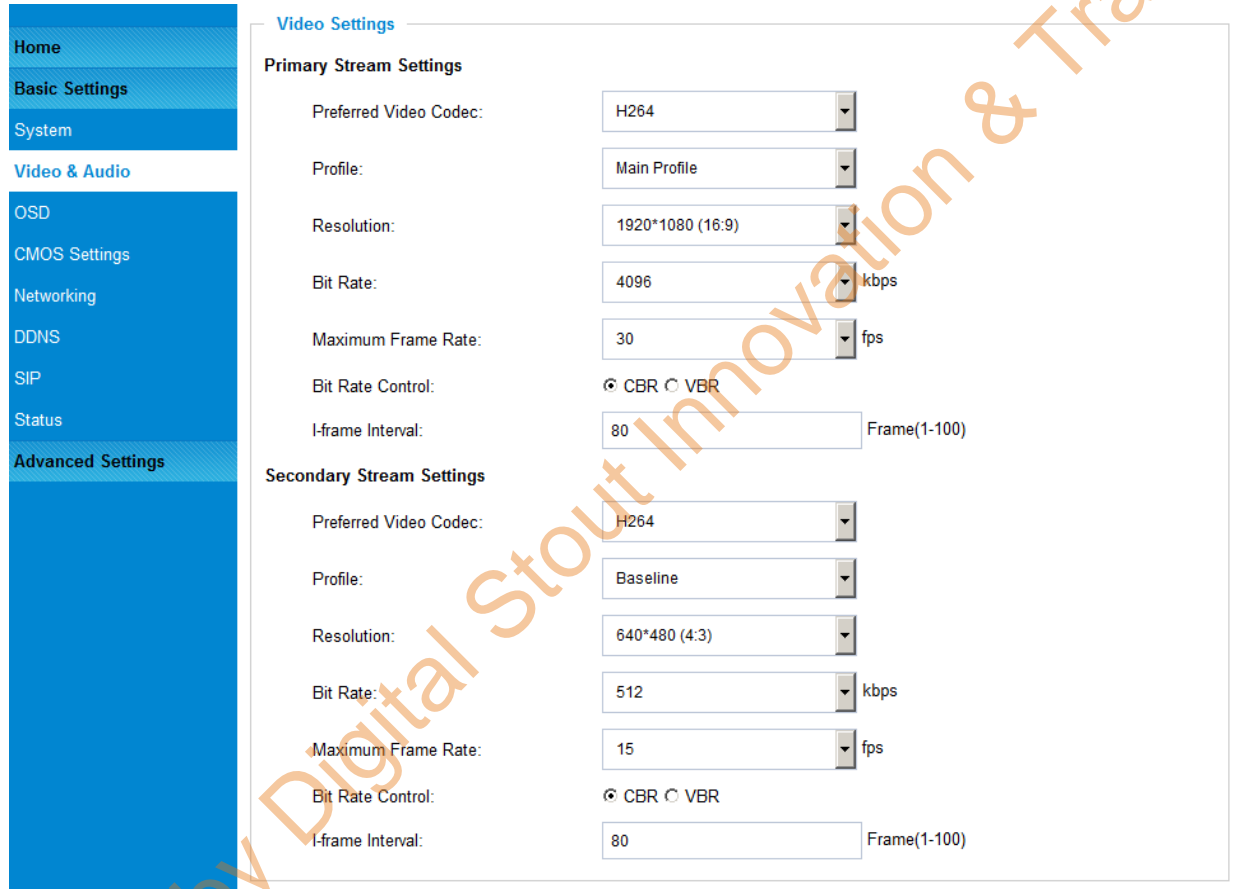

Figure 10-1: Video & Audio Settings Page

### Video Settings

- **Primary Stream Settings:**
  - Preferred Video Codec: MJPEG and H.264 supported, H.264 recommended.
  - Profile: H.264 profile selection. Default is “Main Profile.”
  - Resolution: The resolution in pixels used at video image
  - Bit Rate: video bit rate or bandwidth used
  - Maximum Frame Rate: Maximum frame rate used (more data if big frame used)
  - Bit Rate Control: Constantly bit rate, or variable bit rate
  - Image Quality: Image quality used when Variable Bit Rate used
  - I-frame Interval: I-frame interval (suggested 2~3 times of frame rate)
  
- **Secondary Stream Settings:** Same as primary stream.

**NOTE:**

- *H.264 suggested if camera needs to be viewed via Internet.*
- *The definition of Baseline, Main Profile and High profile of H.264 please refer to:*  
[http://en.wikipedia.org/wiki/H.264/MPEG-4\\_AVC](http://en.wikipedia.org/wiki/H.264/MPEG-4_AVC)
- *If MJPEG selected, reduce max. frame rate to min. value to save bandwidth and get better image*
- *Grandstream IP Camera provides two video streams, user can use them with flexibility. For example, the high-resolution stream for local recording; another low or high resolution for remote monitoring; or vice versa depending application scenarios.*
- *Use below link to calculate bandwidth and storage before installation*  
<http://www.grandstream.com/support/tools/bandwidth-storage-calc>

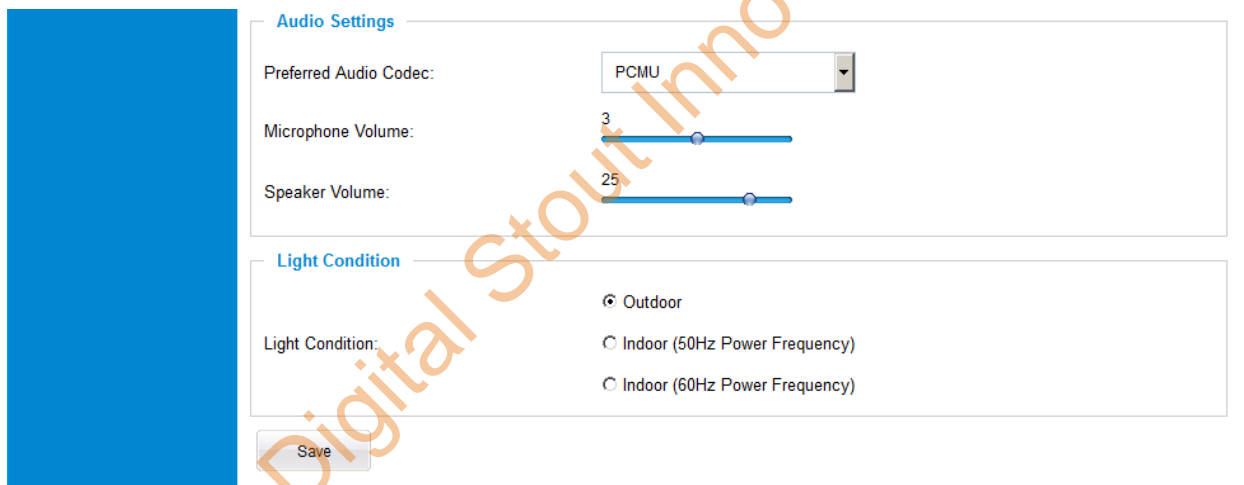

**Figure 10-2: Video & Audio Settings Page**

- **Audio Settings:**
  - Preferred Audio Codec: PCMU, PCMA supported. Audio also can be disabled.
  - Microphone Volume: Slide to adjust microphone gain.
  - Speaker Volume: Slide to adjust the speaker volume connected.
- **Light Condition:** Select correct light condition for the scene monitored: Outdoor, Indoor 50Hz power frequency (Europe, China, etc.) or 60Hz power frequency (US, Japan, etc.). Wrong setting will affect image quality under fluorescence light condition.

## OSD Setting Page

Figure 11: OSD Settings Page

- **On Screen Display (OSD):**
  - OSD Text: Display time stamp and text on the video screen. Inputted text (to identify the camera) shown on the screen.
  - OSD Position: Show the OSD in either top or bottom position on screen.
  - OSD Date Format: OSD Date format, choose based on user preference.
  - Display Time: When checked, time will be displayed inside the video image
  - Display Text: When checked, inputted text will display on video image

## CMOS Settings Page

This page allows user to adjust the CMOS parameters:

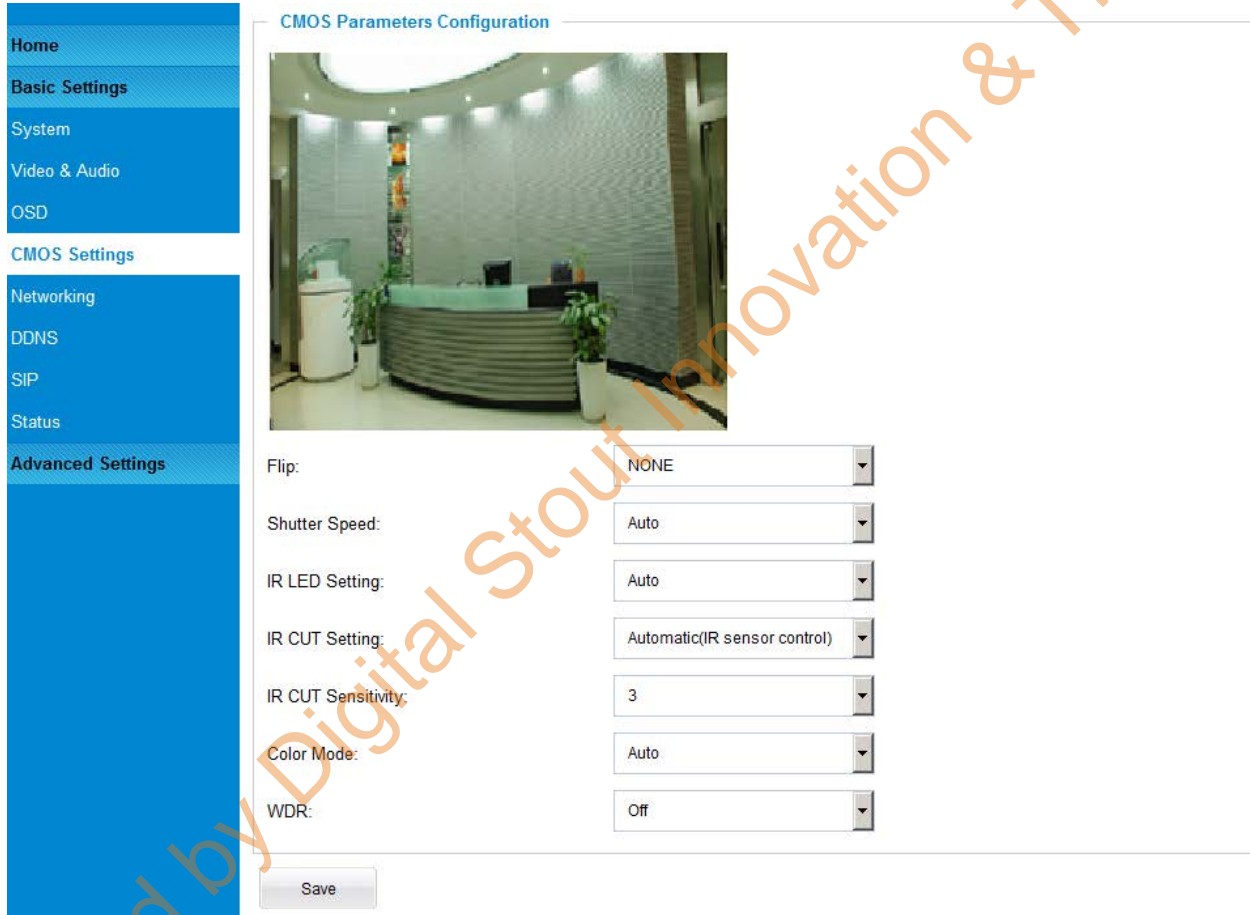

**Figure 12: CMOS Settings Page**

- **Flip:** Pull down to choose video flip, either vertically or horizontal or both.
- **Shutter Speed:** Camera Shutter Speed. There are 10 options, with Auto, 1/30 (slowest), 1/60, 1/125, 1/250, 1/500, 1/1000, 1/2000, 1/5000 and 1/10000 (fastest)
- **IR LED Setting:** Auto, or manually turn ON or turn OFF the LED light. Default Auto  
*Manually On/Off LED light applied to save power if camera powered by battery.*
- **IR CUT Setting:** Manual, Automatic (IR Sensor control) or Time Schedule Mode (configurable Daytime Schedule for user's flexibility) to switch the mechanical IR\_CUT.
- **IR CUT Sensitivity:** Sensitivity of IR Sensor to trigger the IR CUT; 5 levels total and 5 highest sensitivity.
- **Color Mode:** Camera Color Mode. There are three options: Color, Black/White, Auto (Default).
- **WDR** Digital WDR or eWDR, On/Off switch, default is Off. (FHD Models Only)

**NOTE:**

- *Auto option recommended for Shutter Speed, IR CUT Setting and Color Mode.*
- *WDR feature has to be used where appropriate: It has been developed specifically for scenarios with simultaneously light and dark areas in the field or vision, not for solely low light scenes or bright light scenes.*
- *You should first consider where and what you want to monitor and to what level of detail and consider the lighting conditions present, because this will effect where you should place the camera for the best results*
- *If the camera also needs to operate at night, it may be beneficial to disable the WDR function (if there is no high contrasting light) in order to maximize the camera's low light performance*

## Networking Setting Page

This page allows user to configure network related parameters:

**IP Address Configuration**

Dynamically Assigned via DHCP

Statically Configured as:

IP Address:

Subnet Mask:

Default Gateway:

**DNS Configuration**

Obtain DNS Server Address Automatically

Use the Following DNS Server Address:

Primary DNS Server:

Secondary DNS Server:

**HTTP**

HTTP Port:

**Figure 13: Networking Setting Page**

- **IP Address Configuration:**
  - Dynamically Associated via DHCP: Camera IP address configuration
  - Statically Configured as: Default setting, DHCP server assign IP to camera.
- **DNS Configuration:** Static IP address configuration
- **HTTP:** DNS server IP. Must be configured if using static IP.
- **HTTP:** Web access TCP port, default 80.

**NOTE:**

- *If camera behind SOHO router with port forwarding configuration for remote access, static IP or static DHCP has to be used to avoid IP address change after router reboot.*
- *TCP port above 5000 suggested if Port Forward HTTP for remote access, due to some ISP would block port 80 for inbound traffic. For example, change the default HTTP port from 80 to 8088, to make sure the TCP port not likely blocked.*
- *In addition to HTTP port, RTSP port is also required to configure via port forward, so remote party can view the video stream.*
- *If revise the default TCP port 80 to port “A”, then RTSP port should be “2000+A” (changed from default TCP 554). Both TCP port “A” and “2000+A” should be configured for port forwarding in the router. For example, the HTTP port changed to 8088, the RTSP port now should be 10088, both TCP ports 8088 and 10088 should be configured for port forwarding in order for remote camera access: 8088 for web portal, 10088 for video streaming.*

## DDNS Settings Page

This page allows user to configure dynamic DNS related parameters:

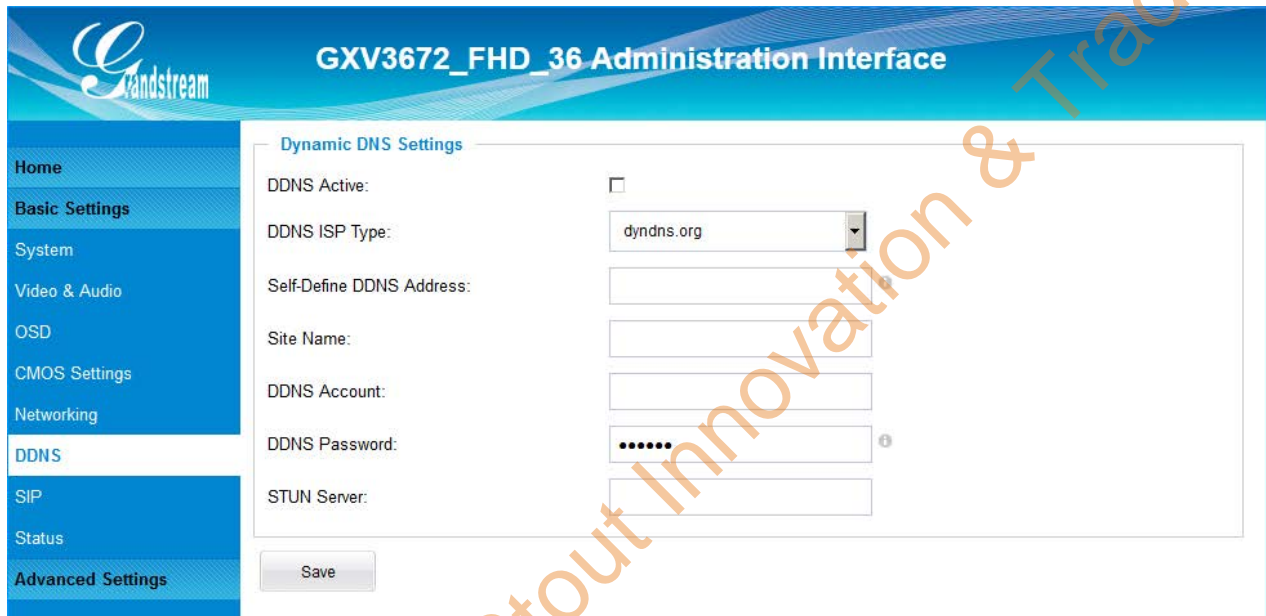

**Figure 14: DDNS Setting Page**

- **DDNS Active:** Enable DDNS by check this field.
- **DDNS ISP Type:** Select the DDSN service provider from the pull-down menu list
- **Self-Define DDNS Address:** Input the self-defined DDNS address
- **Site Name:** DDNS site name
- **DDNS Account:** DDNS account name
- **DDNS Password:** DDNS password
- **STUN Server:** Stun server FQDN or IP. If device behind a non-symmetric router, STUN server can help to penetrate & resolve NAT issue.



## SIP Setting Page

GXV3672\_HD/FHD v2 can be configured as SIP endpoint to call out when alarm triggered; or allow permitted number to call in to check the video if Grandstream video IP phone is used.



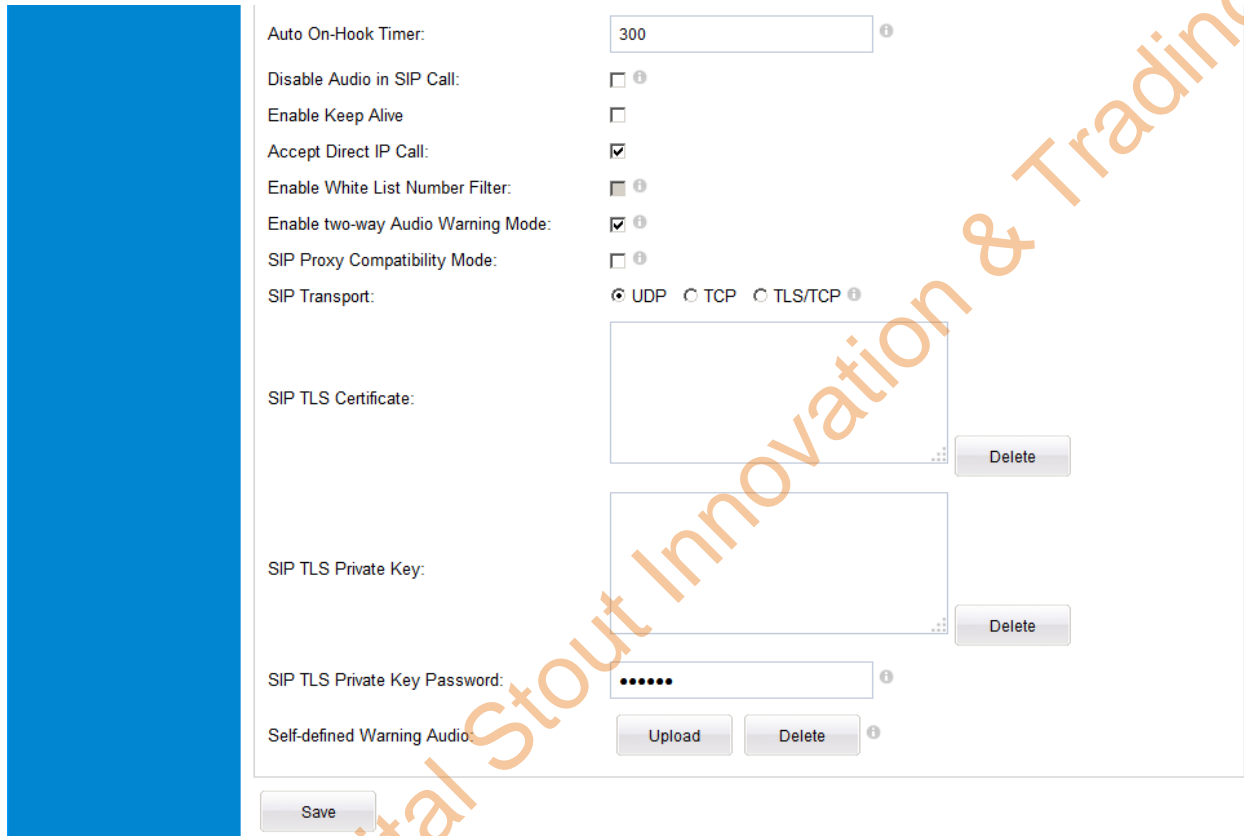

Figure 15-1: SIP Setting Page

- **Registered:** SIP registration status. Display “Online” in Green, “Offline” in Red.
- **Unregistered on Reboot:** If checked and SIP server support, reboot camera will unbind all registered end points using this SIP account.
- **Account Name:** SIP account name used for self-identification.
- **SIP Server:** FQDN or IP of SIP server from VoIP service provider
- **Outbound Proxy:** IP or FQDN of Outbound proxy server, helps penetrate NAT/Firewall
- **SIP User ID:** SIP username, or telephone number from ITSP
- **Authenticate ID:** Authenticate ID used by SIP proxy
- **TEL URI:** URI or Phone selection by ITSP, see webpage help tips “”
- **Authenticate Password:** Authenticate password used by SIP proxy
- **STUN Server:** STUN server used to resolve NAT if have
- **Stream:** Which stream used for SIP call. Default 2<sup>nd</sup> stream, strongly recommended due to bandwidth and data involved at video call.
- **Preferred Vocoder:** Audio codec used for SIP call, only G.711 A or U supported.
- **Registration Expiration:** Registration expiration time, default 3600 seconds
- **Local SIP Port:** Local SIP port, default 5060
- **Local RTP Port:** Local RTP port for media, default 5004



Auto On-Hook Timer:

Disable Audio in SIP Call:

Enable Keep Alive:

Accept Direct IP Call:

Enable White List Number Filter:

Enable two-way Audio Warning Mode:

SIP Proxy Compatibility Mode:

SIP Transport:  UDP  TCP  TLS/TCP

SIP TLS Certificate:

SIP TLS Private Key:

SIP TLS Private Key Password:

Self-defined Warning Audio:

**Figure 15-2: SIP Setting Page**

- **Auto On-Hook Timer:** Timer (seconds) for automatic disconnecting the call. Default 300.
- **Disable Audio in SIP Call:** Disable or turn off audio of camera when SIP call established.
- **Enable Keep Alive:** Checked to help NAT resolution, sending alive packets.
- **Accept Direct IP Call:** Check to accept peer-to-peer IP call in LAN w/o SIP server.
- **Enable White List Number Filter:** Check to allow only white list number to call in, for security.
- **Enable two-way Audio Warning:** Check to enable two-way audio when call established (Default)
- **SIP Proxy Compatibility Mode:** Check to enable more proxy compatibility with cost of bandwidth, the SIP call will send both audio and video no matter what.
- **SIP Transport:** SIP transport protocol, UDP as default.
- **SIP TLS Certificate:** Copy/Paste the TLS certificate here for encryption.
- **SIP TLS Private Key:** Input private key here for TLS security protection.
- **SIP TLS Private Key Password:** The password for SIP TLS private Key.
- **Self-define Warning Audio:** Upload self-defined alarm warning message audio. (Format: G.711 .WAV format, File Size <= 300KB, Linear PCM, 8KHz Sampling Rate, 16bit, Single Channel)

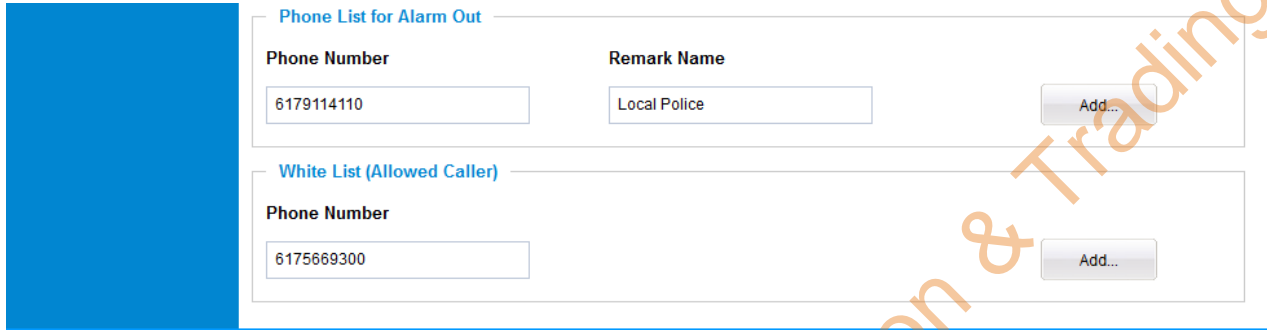

The screenshot shows a web interface for SIP settings. On the left is a blue sidebar. The main content area has two sections:

- Phone List for Alarm Out:** A table with two columns: 'Phone Number' and 'Remark Name'. The first row contains '6179114110' and 'Local Police'. There is an 'Add...' button to the right of the table.
- White List (Allowed Caller):** A section with a 'Phone Number' column containing '6175669300' and an 'Add...' button to its right.

**Figure 15-3: SIP Setting Page**

- **Phone List for Alarm Out):** Callee or call receiver’s number when alarm call triggered.
- **White List (Allowed Caller):** Phone numbers allowed calling into the camera.

**NOTE:**

- *GXV3672\_HD/FHD v2 requires external microphone and amplified speakers connected to support audio calls*

## Status Page

This page shows the GXV3672\_HD/FHD v2 operation status:



**GXV3672\_FHD Administration Interface**

**System Statistics**

Product Model:	GXV3672_FHD
Hardware Version:	V2.0A
Part Number:	9670004320A
Bootloader Version:	1.0.3.5
Core Version:	1.0.3.5
Base Version:	1.0.3.5
Firmware Version:	1.0.3.5
System Up Time Since:	13 days 3 hours 25 minutes

**Network Status**

MAC Address:	00:0B:82:5C:E0:AE
LAN IP Address:	192.168.22.110
LAN Subnet Mask:	255.255.255.0
LAN Default Gateway:	192.168.22.1
DDNS Status:	Disabled
SIP Registered:	Offline

**IR CUT Status**

IR CUT Status:	Daytime
----------------	---------

**Figure 16: Status Page**

**NOTE:**

- *IR CUT Status showed Daytime or Night*
- *When SIP account registered, the status will display “Online” in Green.*
- *When SIP account unregistered, the status will display “Offline” in Red, as below.*

SIP Registered: Offline

## ADVANCED SETTINGS EXPLANATION

### User Management Page

This page allows user to do user management:

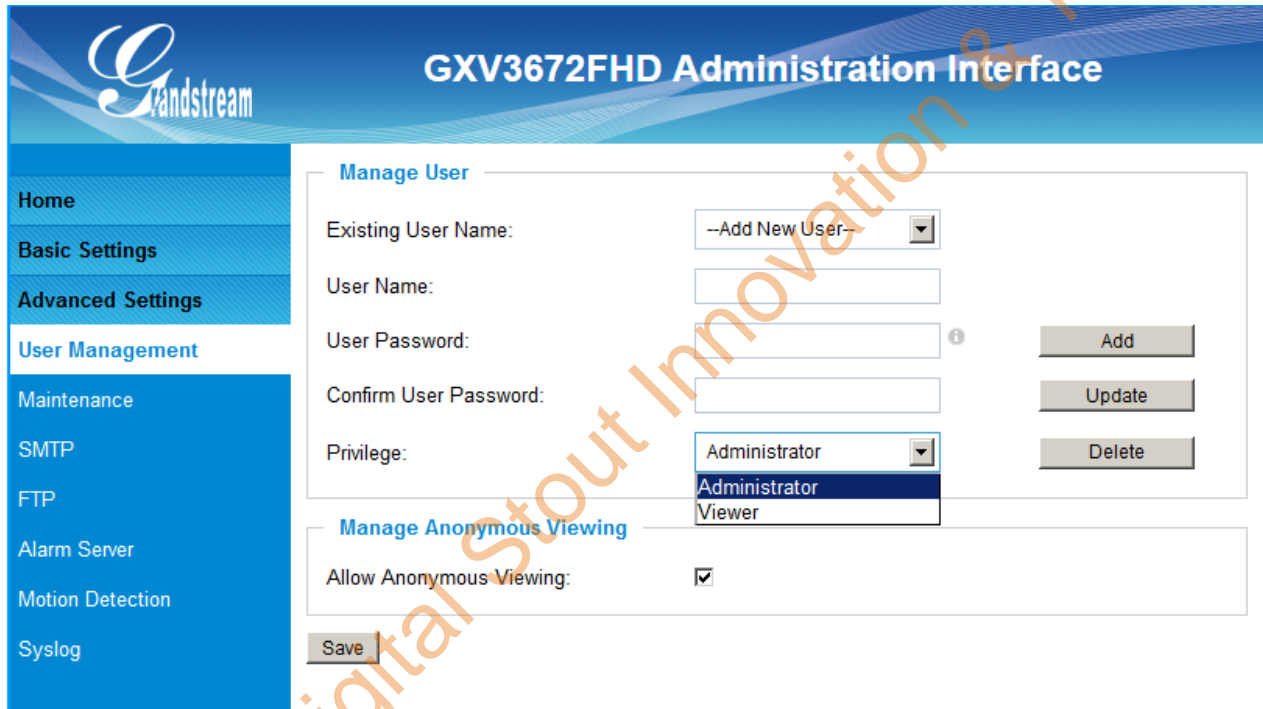
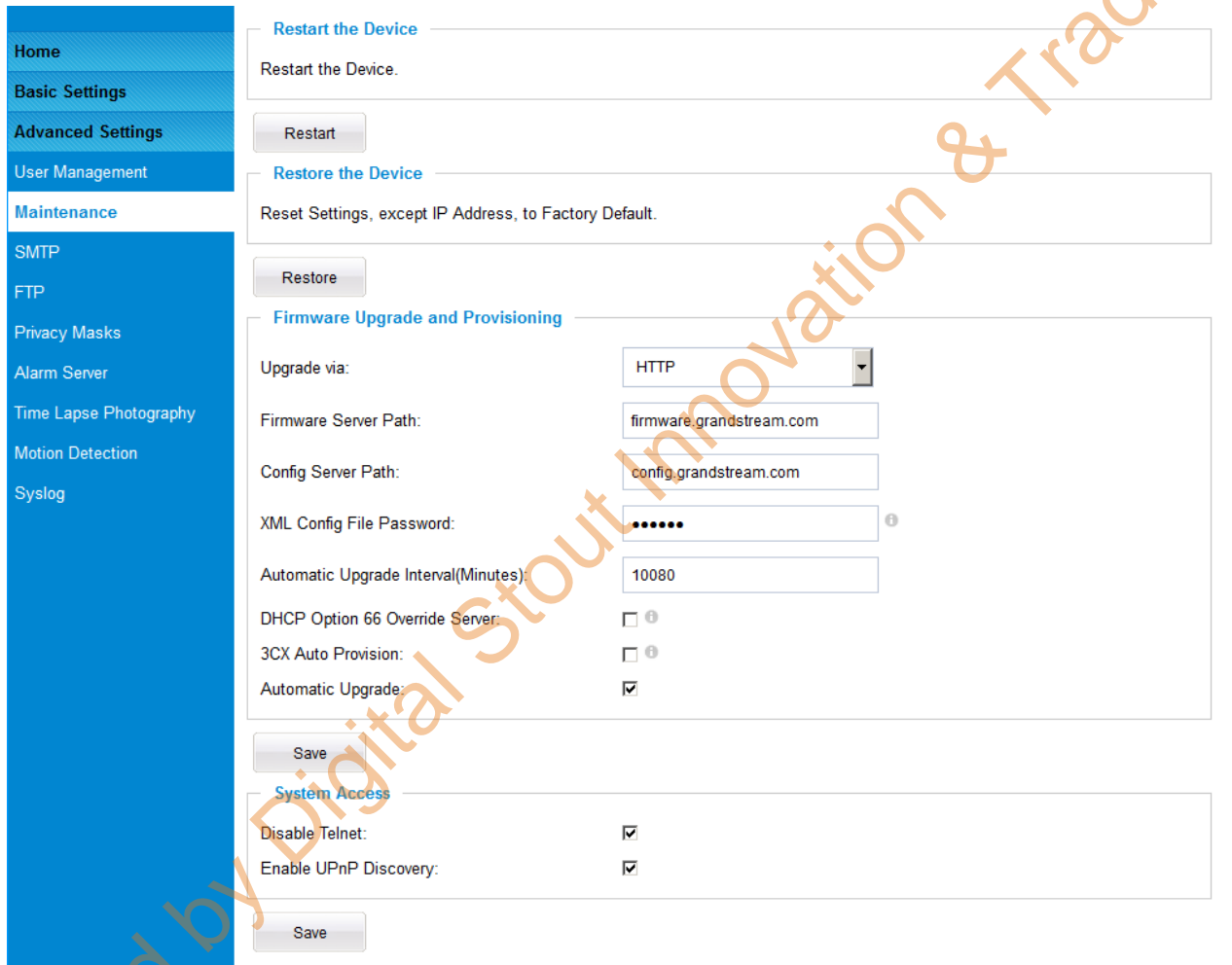

Figure 17: User Management Page

- **Existing User Name:** Allow revise existing user or add new user
- **User Name:** The name of user need to be revised
- **User Password:** New password if revise password
- **Confirm User Password:** Re-enter the new password for verification
- **Privilege:** Choose user privilege
- **Allow Anonymous Viewing:** When checked, no security enhanced. Any person can view the camera if knowing the IP or FQDN of the camera, but can NOT change anything, just view ONLY.

## Maintenance Page

This page allows user to maintain the camera:



**Figure 18: Maintenance Page**

- **Restart:** When clicked, the camera will reboot or restart (soft reboot).
- **Restore:** When clicked, the camera will be reset to factory default, wiping out all the configurations (except IP address)
- **Upgrade via:** Upgrade firmware via TFTP, HTTP or HTTPS
- **Firmware Server Path:** Server path holding the firmware
- **Config Server Path:** Server path holding the configuration file (auto provisioning)
- **XML Config File Password:** Password for encrypt the XML based configuration file
- **Automatic Upgrade Interval (Minutes):** Time interval for automatic upgrade, default 10080
- **DHCP Option 66 Override Server:** Enabled to redirect firmware/configuration server path.
- **3CX Auto Provision:** Enabled to use 3CX as SIP server to auto provisioning the device.
- **Automatic Upgrade:** Checked to enable automatic firmware upgrade and provisioning.

### System Access

- **Disable Telnet:** Check to disable Telnet to enhance security.
- **Enable UPnP Discovery:** Used for UPnP automatic discovery of the device in related network environment. Default enabled.

### NOTE:

- *Only XML based automatic provisioning is supported by GXV3672\_HD/FHD v2.*

Supplied by Digital Stout Innovation & Trading FZE

Supplied by Digital Stout Innovation & Trading FZE

This page intentionally left blank



## SMTP Setting Page (Email Alarm)

This page allows user to configure email client to send out email when alarm triggered:

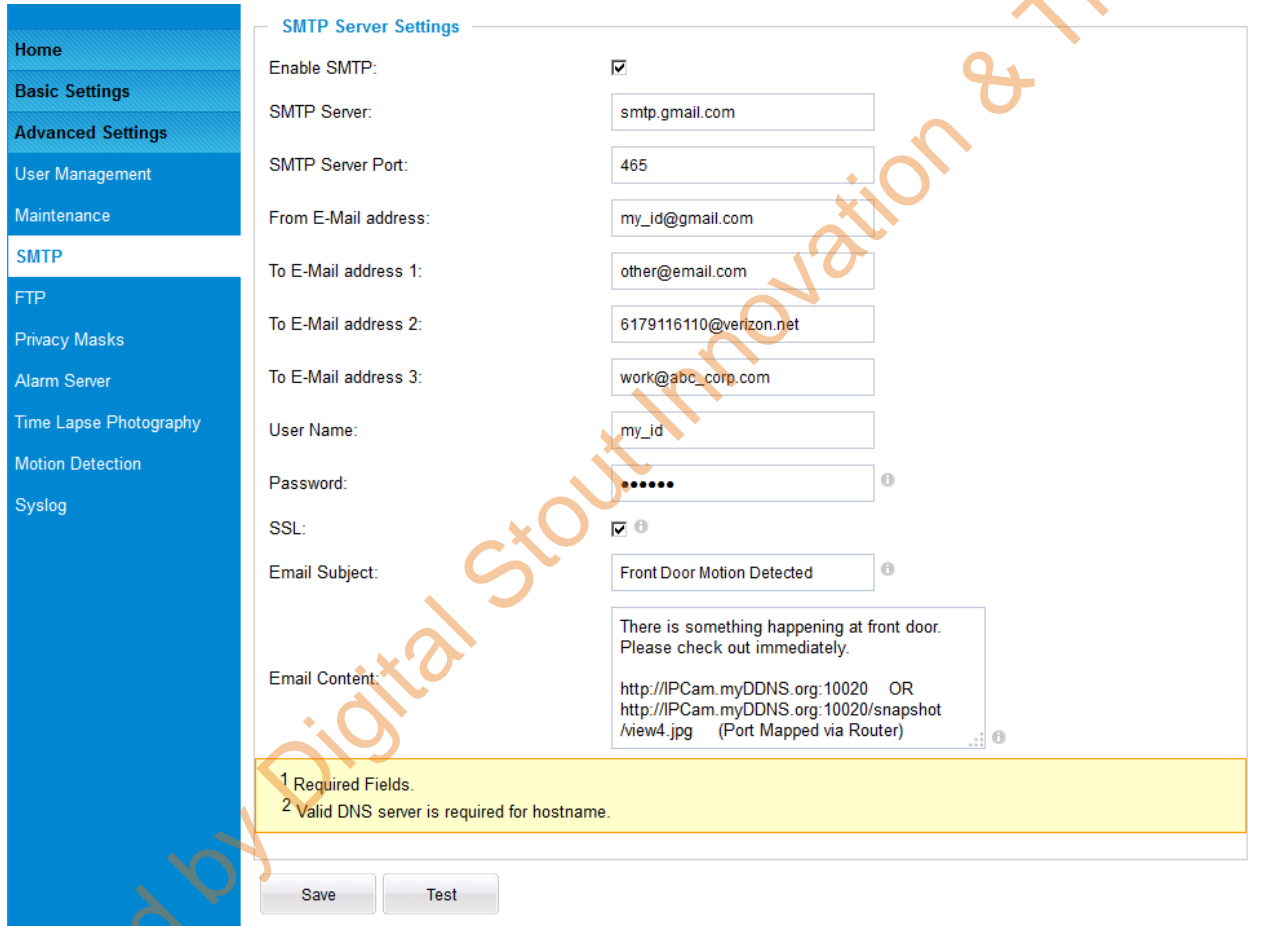

**SMTP Server Settings**

Enable SMTP:

SMTP Server:

SMTP Server Port:

From E-Mail address:

To E-Mail address 1:

To E-Mail address 2:

To E-Mail address 3:

User Name:

Password:

SSL:

Email Subject:

Email Content: 

There is something happening at front door.  
 Please check out immediately.  
  
 http://IPCam.myDDNS.org:10020 OR  
 http://IPCam.myDDNS.org:10020/snapshot  
 /view4.jpg (Port Mapped via Router)

1 Required Fields.  
 2 Valid DNS server is required for hostname.

Save Test

Figure 19-1: SMTP Setting Page

- **Enable SMTP:** When checked, email client is enabled.
- **SMTP Server:** SMTP Email Server IP or Domain Name
- **SMTP Server Port:** Port number used by server to send email
- **From Email address:** The email address of alarm email sending from, usually client email ID
- **To E-Mail address:** The email address to receive the alarmed email, total 3 included.
- **User Name:** Email client User ID
- **Password:** Email client password
- **SSL:** Check if the SMTP email server requires SSL
- **Email Subject:** Customizable email subject for user convenience
- **Email Content:** Customizable email body for user convenience

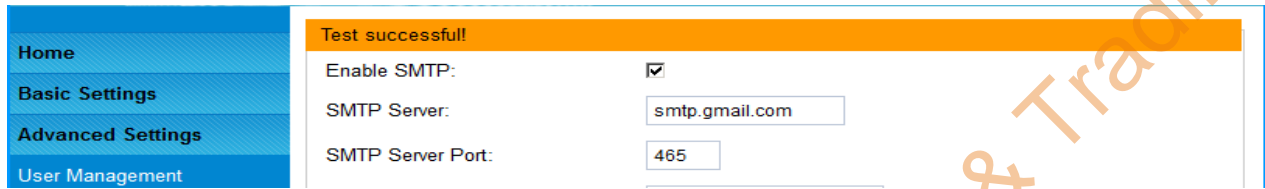

The screenshot shows a web interface for SMTP settings. On the left is a navigation menu with 'Home', 'Basic Settings', 'Advanced Settings', and 'User Management'. The main content area has an orange header bar that says 'Test successful!'. Below this, there are three configuration items: 'Enable SMTP:' with a checked checkbox, 'SMTP Server:' with a text box containing 'smtp.gmail.com', and 'SMTP Server Port:' with a text box containing '465'.

**Figure 19-2: SMTP Setting Page**

**NOTE:**

- Click “Save” to save the email configuration information.
- Click “Test” after configuration, if setting is correct, a test email will send out and “Test successful!” orange bar will display like below

## FTP Settings Page (Upload Alarm)

This page allows user to configure FTP parameters to upload the alarm or video recording:

**FTP Settings**

Enable FTP:

FTP Server:

FTP Server Port:

User Name:

Password:

Path:

Valid DNS server is required for hostname.

**Figure 20: FTP Setting Page**

- **Enable FTP:** When checked, built-in FTP client is enabled.
- **FTP Server:** IP or Domain name of FTP site or server
- **FTP Server Port:** TCP port for FTP server, default port number 21
- **User Name:** FTP server User ID
- **Password:** FTP server user password
- **Path:** Path in the server where upload files are stored.

**NOTE:**

- Click “Save” to save the FTP configuration information.
- Click “Test” after configuration, if setting is correct, a test FTP operation will be performed and “Test successful!” yellow bar will display if the operation is successful.

Test successful!

## Privacy Masks

This page allows user to configure privacy masks up to 4 different regions.

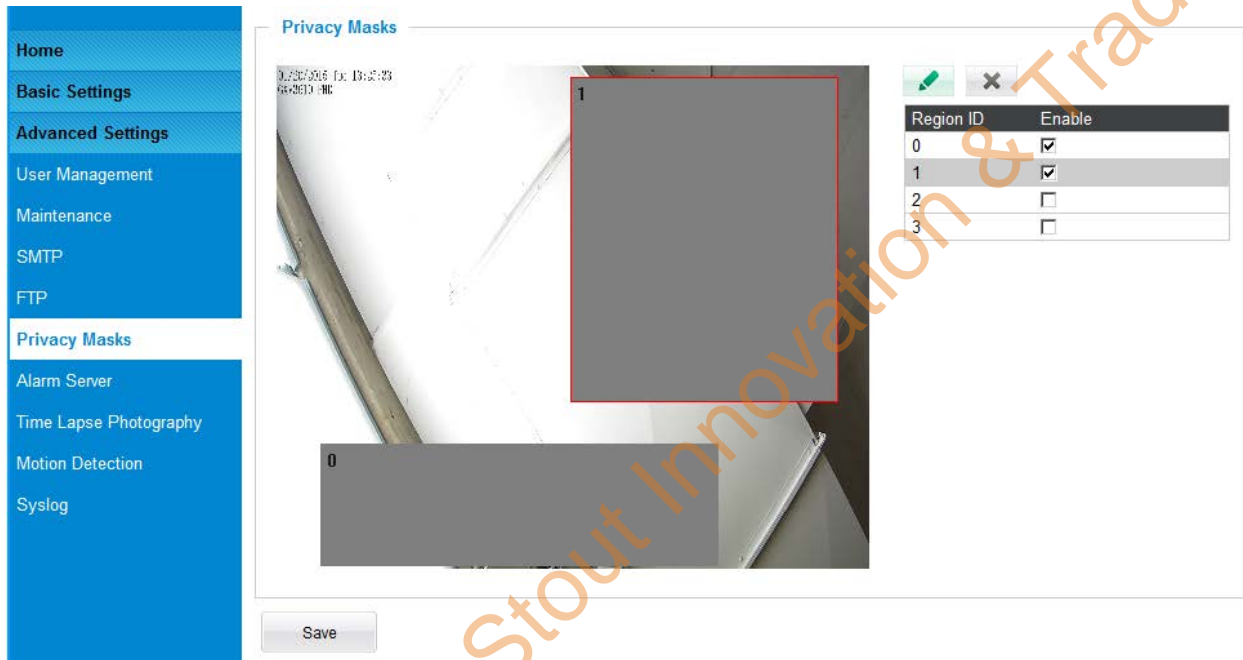

**Figure 21: Privacy Masks Configuration Page**

Select different region requiring privacy mask, configure and save the configuration.

When privacy mask enabled, the video at related region will be masked by black color and no video displayed inside that mask.

## Alarm Server Settings Page (Upload Alarm to supported VMS or HTTP Server)

This page allows user to configure alarm HTTP server to upload alarms (Upload Alarms to VMS platform supported or HTTP Server for processing):



Figure 22: Alarm HTTP Server Setting Page

- **Server Name:** The name of HTTP server or VMS system
- **URL:** URL of the Server
- **User Name:** User ID from that Server
- **Password:** Password for that User ID

### NOTE:

- Grandstream provide HTTP API to help third party companies by using HTTP server or VMS to develop further solutions for their customers.

[http://www.grandstream.com/products/surveillance/general/documents/grandstream\\_http\\_api.pdf](http://www.grandstream.com/products/surveillance/general/documents/grandstream_http_api.pdf)

- Grandstream IP Camera and DVS (including GXV3672\_HD/FHD v2) are ONVIF certified.

## Time Lapse Photography

This page allows user to configure Time Lapse Photography (or period snapshot).

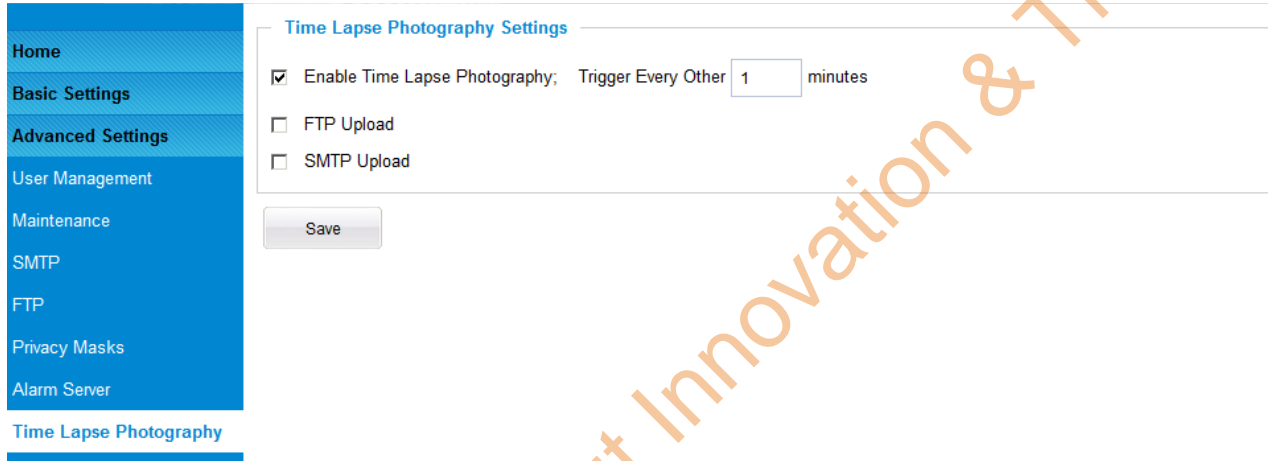
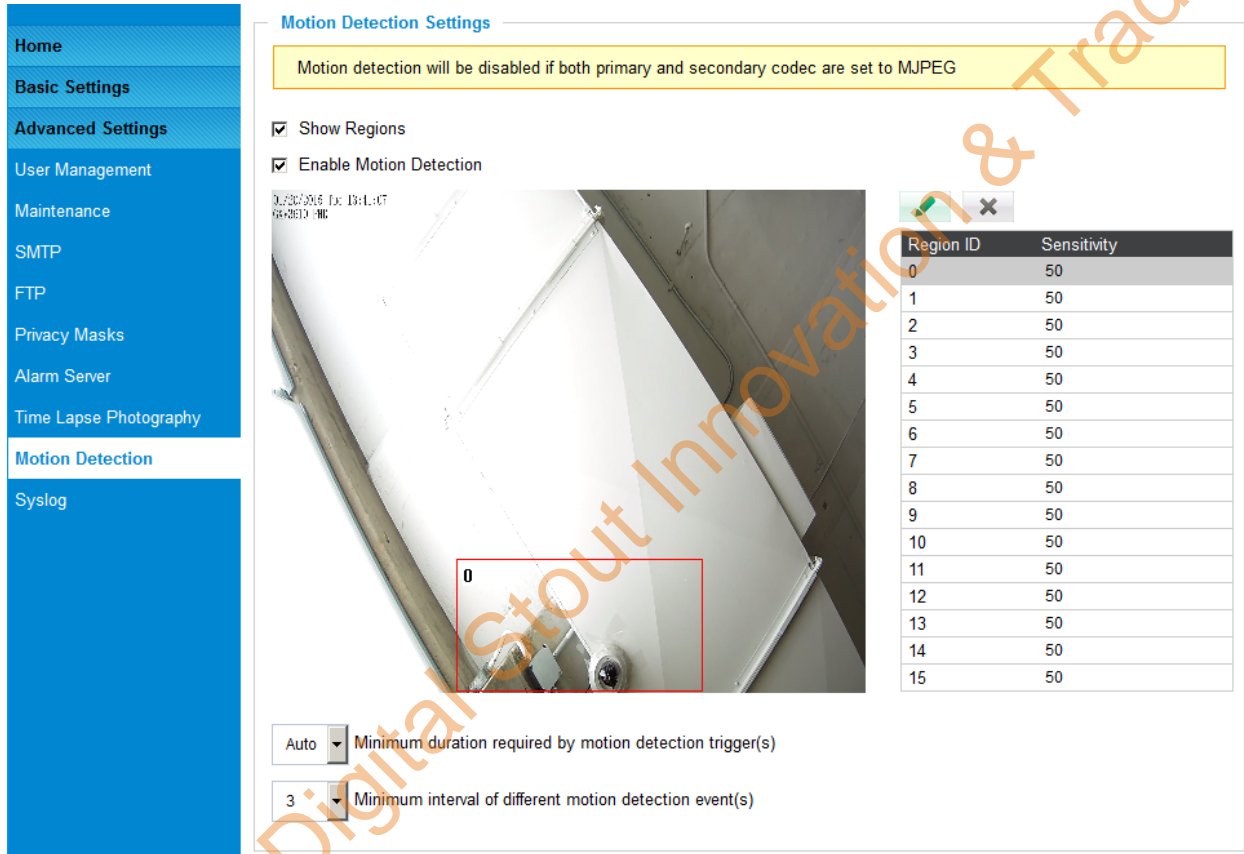

**Figure 23: Time Lapse Photography Configuration Page**

- **Enable Time Lapse Photography:** Check to enable this feature. User can configure the timer or duration of the triggering moment, minimum value is 1 minute.
  - **FTP Upload:** Enabled will allow device to upload the snapshots to FTP server. The FTP server is configured at “FTP” server page illustrate before.
  - **SMTP Upload:** Enabled will allow device to email the snapshots via email server. The email server is configured at “SMTP” configuration page.
- Click “Save” button to save the changes made and the feature will take effect immediately.

## Motion Detection Configuration Page (Set Alarm)

This page allows user to configure motion detection to trigger alarms:



**Motion Detection Settings**

Motion detection will be disabled if both primary and secondary codec are set to MJPEG

Show Regions

Enable Motion Detection

0:25:50.6 Do: 13:1:07  
R:2820-HIC

Region ID	Sensitivity
0	50
1	50
2	50
3	50
4	50
5	50
6	50
7	50
8	50
9	50
10	50
11	50
12	50
13	50
14	50
15	50

Auto Minimum duration required by motion detection trigger(s)

3 Minimum interval of different motion detection event(s)

Figure 24-1: Motion Detection Configuration Page

- Show Regions:** When checked, Motion Detection region with number will be displayed as a white rectangle in the screen. When “Edit” clicked, the Rectangle will become Red, as shown in Figure 16-1.
- Enable Motion Detection:** When checked, Motion Detection is enabled. There are total 16 regions be available for MD configuration, from region 0 to 15. Select and highlight the number of region to configure the MD and the sensitivity.
- Minimum duration required by motion detection trigger(s):** Min. period (in second) to identify as a valid MD event. Default is Auto, max. value is 5 second. The setting helps to reduce false alarm based on user’s scenarios.
- Minimum interval of different motion detection event(s):** Min. time frame (in second) to identify as different MD events if there are constant motions. Max. value is 60 seconds or 1 minute. This setting helps accuracy of MD triggered recording.

**Alarm Action**

Record Video From Pre Alarm Up to  seconds to After Alarm Up to  seconds ⓘ

Voice Alarm to SIP Phone

Upload to Alarm Center

Upload to Alarm HTTP Server

Record Video and Upload to FTP Server

Email and FTP upload JPEG

Pre Alarm Up to  seconds to After Alarm Up to  seconds

**Figure 24-2: Motion Detection Configuration Page**

**Alarm Action:**

- **Record Video From Pre Alarm Up to XXX seconds to After Alarm Up to XXX seconds:**  
 This setting to allow configure pre/post alarm video for applications to utilize. MJPEG is NOT supported for this feature.
- **Voice Alarm to SIP Phone:**  
 If SIP server or peer IP device configured, check this will allow MD event to trigger alarm SIP call to pre-configured number.
- **Alarm Output:**  
 Select will allow MD to send alarm to Alarm Output interface.
- **Upload to Alarm Center:**  
 When checked, the alarm video will be transferred to Alarm Center, like Grandstream free GSurf\_Pro VMS software.  
When peering with GXV3500 Decoder for Remote Alarm Out, this field has to be selected.
- **Upload to Alarm Center:**  
 When checked MD alarm will be sent to 3<sup>rd</sup> party Alarm Center.
- **Upload to Alarm HTTP Server:**  
 When checked MD alarm will be send to 3<sup>rd</sup> path HTTP server via Grandstream HTTP API.
- **Record Video and Upload to FTP Server:**  
 When checked and FTP server configured, the recorded video will be send to the configured FTP server.
- **Email and FTP upload JPEG:**  
 When checked, snapshots of trigger moment will be emailed to pre-configured email account and also uploaded to FTP server if configured. The pre/post alarm snapshot numbers can be configured based on time (in second) to meet user's requirement.



### Time Schedule Config:

Click the “Time Schedule Config” will bring up following interface to allow user to configure the Time Schedule for the Motion Detection to take action.

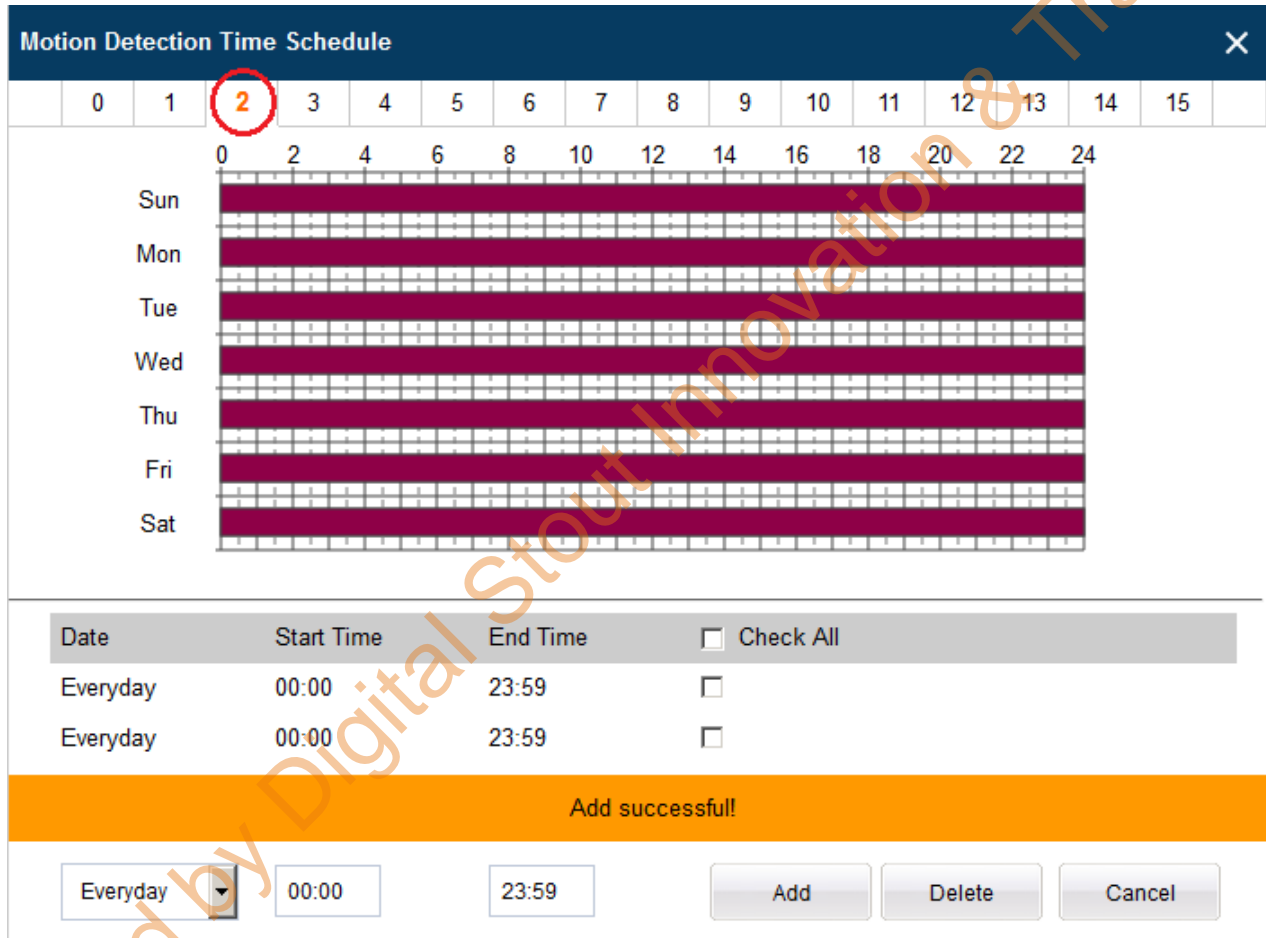

Date	Start Time	End Time	<input type="checkbox"/> Check All
Everyday	00:00	23:59	<input type="checkbox"/>
Everyday	00:00	23:59	<input type="checkbox"/>

Add successful!

**Figure 24-3: Motion Detection Schedule Configuration Page**

- As shown in Figure 15-2, user can configure the Motion Detection Region with related Start and Stop time to control the motion detection operation.

### NOTE:

- User has to configure the “Time Schedule”; otherwise the Motion Detection Alarm will not work if there is no time schedule configured.
- Grandstream free VMS software can be downloaded from:  
[http://www.grandstream.com/products/tools/surveillance/gsurf\\_pro.zip](http://www.grandstream.com/products/tools/surveillance/gsurf_pro.zip)

Supplied by Digital Stout Innovation & Trading FZE

This page intentionally left blank

## Remote Alarm\_Out peering with GXV3500 Decoder

The GXV3672 series IP camera does not have built-in Alarm\_In interface, but when peering with Grandstream GXV3500 encoder/decoder, the GXV3500's built-in Alarm\_Out interface (running at decoder mode) can behave as remote Alarm\_Out of GXV3672 series IP Camera.

The benefit of such peering is the Alarm\_Out circuit is not physically wired into the IP Camera anymore, with the Ethernet network behaving as wiring, the Alarm\_Out circuit can now be located to convenient places where GXV3500 located. This means IP Camera can be in location A, while the Alarm\_Out can be in location B (A and B can be in the same or different places as long as A and B can reach each other via network/internet). This will help a lot of users to monitor site remotely and take appropriate action, because there are situations where location A with cameras but actions have to be taken from location B. With Grandstream's solution, traditional A and B limitation by the cable length is now disappear.

The configuration of such remote Alarm\_Out is very simple:

### GXV3672 Side:

Same configuration as previous Motion Detection configuration, just make sure "Upload to Alarm Center" checked and selected:

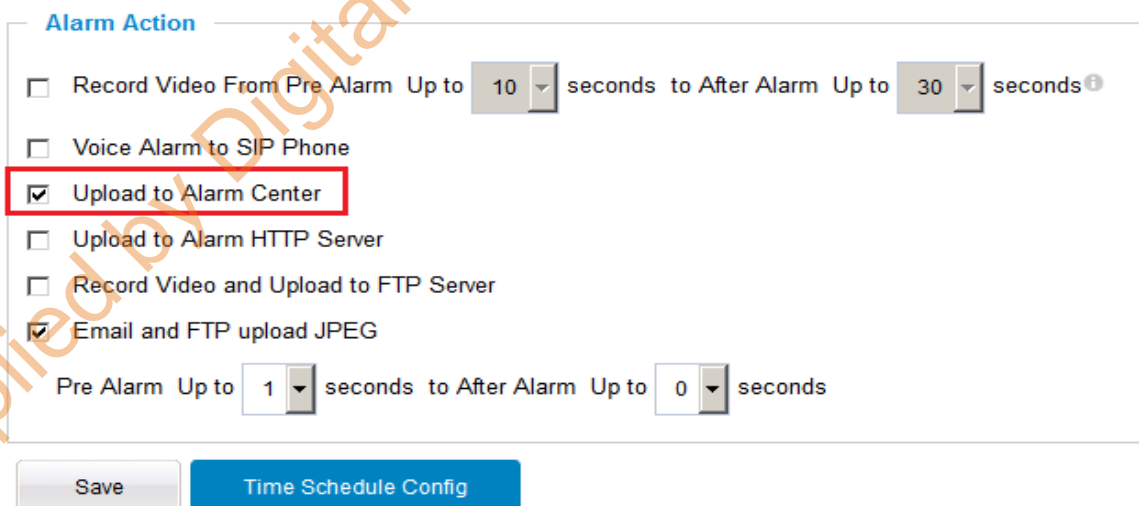

**Alarm Action**

Record Video From Pre Alarm Up to 10 seconds to After Alarm Up to 30 seconds ⓘ

Voice Alarm to SIP Phone

Upload to Alarm Center

Upload to Alarm HTTP Server

Record Video and Upload to FTP Server

Email and FTP upload JPEG

Pre Alarm Up to 1 seconds to After Alarm Up to 0 seconds

Save Time Schedule Config

**Figure 24-4: Remote Alarm\_Out IP Camera Configuration**

### GXV3500 (Decode Mode) Side:

GXV3500 has to be running as Decode when functioning as remote Alarm\_Out of the peering IP Camera. The configuration is as below:

- 1) Input the 2<sup>nd</sup> stream (H.264 used) as the RTSP URL, with correct credentials, as below.
- 2) Only ONE stream (currently decoding stream) the Motion Detection can use the GXV3500 built-in Alarm\_Out interface if there are multiple RTSP URL configured in the GXV3500.

02/04/2015 Wed 16:28:14  
GXV3615WP\_HD

Encode Home Page | Configuration | Language

**Decoder Settings**

Stream Format: RTSP

Default Stream: 2

Enable Patrol:

Video Output Type: Auto or NTSC

Real Size:

Save Start Patrol

rtsp://192.168.11.69:10020/4 Stop

No.	Patrol	RTSP URL	User Name	Password	Description	Time(s)
1	<input type="checkbox"/>	rtsp://192.168.11.69:10020/4	admin	•••••	GXV3615WP_HD	60
2	<input type="checkbox"/>	rtsp://192.168.11.71:10060/4	admin	•••••	GXV3610_FHD	60
3	<input type="checkbox"/>					60

Figure 24-5: Remote Alarm\_Out peering GXV3500 Configuration

**NOTE:**

- GXV3500 is designed to work with analogue camera, therefore resolution more than D1 NOT supported, this is why 2<sup>nd</sup> stream decoding (usually less than D1) used as peering for remote Alarm\_Out. The RSTP setting will be: **rtsp://IPCamera:Port/4** (4 is 2<sup>nd</sup> stream of GXV3672)
- 2<sup>nd</sup> stream also consume less bandwidth therefore good for internet transmission.
- H.264 video codec has to be selected because Motion Detection not supported via MJPEG.
- All Grandstream IP Cameras without built-in Alarm\_Out interface can peer with GXV3500 (Decoder Mode) built-in Alarm\_Out interface for Motion Detection Remote Alarm\_Out.

Alarm\_Out duration can be configured at “System” setting page of GXV3500 Decoder. See below the figure. When Alarm\_Out taking action, the webpage will show the related action.

For example, below the “Digital Output Duration” is selected as “15 seconds” so the Alarm\_Out will act for 15 seconds before revert back to previous state. In below case, the default is circuit “Open”, when Motion Detection alarm triggered, the circuit state changed to “Close”, as illustrated below for 15 seconds and then switch back to previous “Open” state.

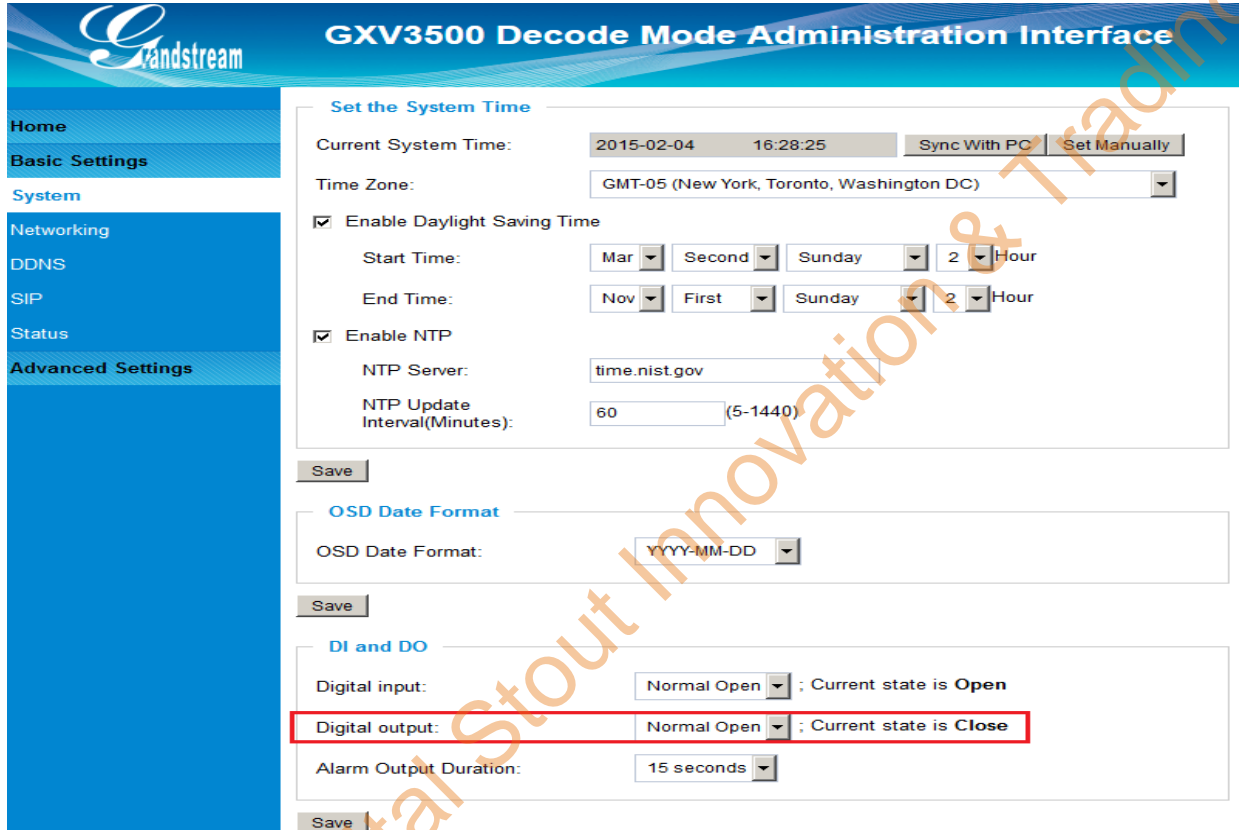

Figure 24-6: Remote Alarm\_Out peering GXV3500 Action Output Display

Unlike the Alarm\_Out interface of Grandstream IP Camera (which using relay switch), the GXV3500 Alarm\_Out is using photo coupler circuit. If connecting to a multi-meter, you will see the Ohm changed from unlimited to several hundred Ohms depending on GXV3500 HW version.

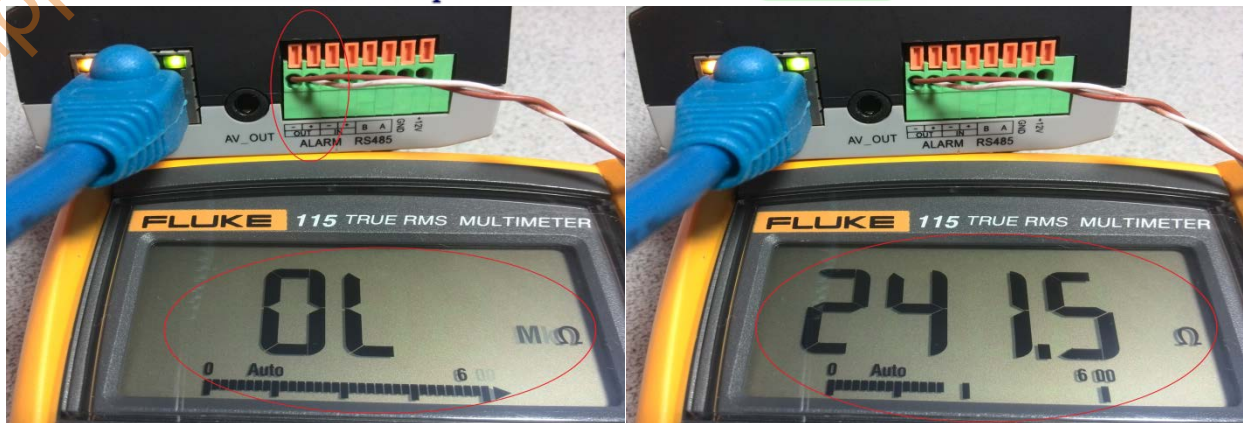
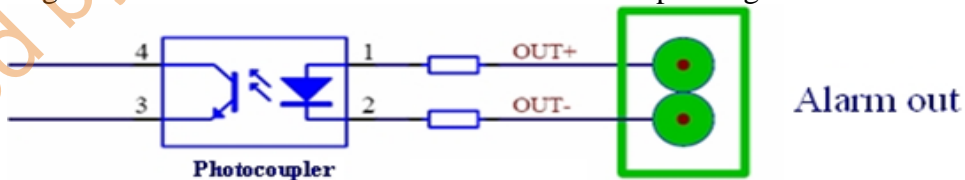

Figure 24-7: Peering GXV3500 Decoder Alarm\_Out Circuit

Supplied by Digital Stout Innovation & Trading FZE

This page intentionally left blank

## Configure SIP Open Door peering with GVR355X NVR

The metal case outdoor IP66 weatherproof IP cameras GXV3672 series do not have built-in Alarm\_In and Alarm\_Out interface. But when combined with Grandstream GVR355X, SIP Proxy or IP-PBX, the GVR355X's built-in Alarm\_In and Alarm\_Out interface can be used to connect to related 3<sup>rd</sup> party device like Door Bell/Intercom and Relay or Door Strike, to accomplish the SIP Open Door function when configured with related SIP IP-PBX.

The benefit of such solution is that the GVR355X can only record all the person pressed the door bell and door can be controlled (local or remotely) via video SIP calls, either via Grandstream IP video hard phone like GXV3240 or GXV3275, or Grandstream GS\_Wave soft phone (pending) running on Android or iOS.

### GXV3672 (IP Camera) Side:

- **Basic - SIP Setting:**



#### IP Camera Basic Settings – SIP Configuration

Make sure configure correct SIP Proxy or IP-PBX by using either FQDN domain name or IP address. Also fill in extension and password, save the setting and make sure the IP camera is registered to the SIP server, as shown in Figure 1, the green “Online” status will be displayed once the IP camera registered to the SIP Proxy or IP-PBX.

At the “Phone List for Alarm Out”, please fill in the extension of the IP video phone to receive the Alarm\_Out calls, this could be Grandstream SIP video hard phone or software phone. Make sure the video phone is indeed registered to the SIP Server or IP-PBX.

**Phone List for Alarm Out**

Phone Number	Remark Name	
806	IP Video Phone	Add...

**White List (Allowed Caller)**

Phone Number	
	Add...

Once click “Add”, the phone number will be added as shown in below:

**Phone List for Alarm Out**

Phone Number	Remark Name	
		Add...
806	IP Video Phone	<input type="checkbox"/>
	<input type="checkbox"/> Check All	Remove

In this example configuration, the IP camera with extension number 809, once Alarm\_In (sending from GVR355X via the Door Bell Operation) triggered, will make SIP phone call to extension 806, the IP Video Phone configured to receive the Alarm\_Out call to execute the open door operation. The IP video phone could be Grandstream GXV3240/3275 hard phone, or GS\_Wave soft phone running at Smartphone, like Android or iOS (Pending).

This finished the SIP related configuration on IP Camera side.

**NOTE:**

- Make sure to DISABLE the Voicemail or Faxmail at SIP Proxy or IP-PBX side for the extension that receiving the Alarm\_Out call. (Extension 806 in the example).



## GVR355X (NVR) Side:

GVR355X has to configure the “IO Alarm Config” correctly to allow the “SIP Open Door” feature function properly.

- **Software Configuration**

GVR355X can be configured either via Local View interface or WebGUI interface. Below example is using web interface of GVR3552, the GVR3550 is similar:

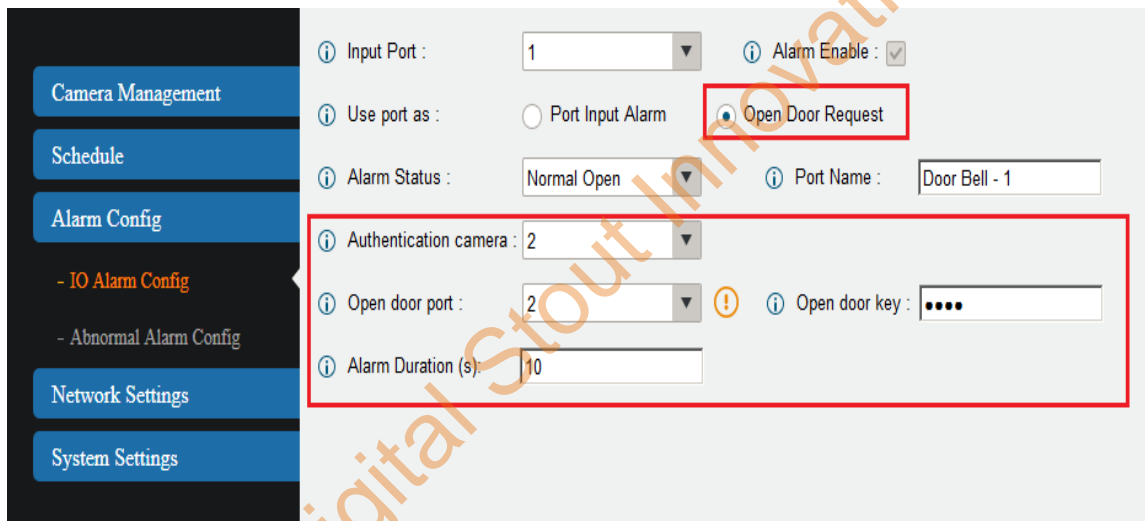

**Figure 25-1: Open Door Configuration**

- **Alarm\_In Port:**

Select “Input Port” from pull-down selection, this port has to be connected to the wire connecting to the Door Bell or Intercom circuit.

- **Alarm\_Out Configuration:**

Select “Open Door Request” to enable “Open Door” feature.

Once selected, the system will automatically enable the Alarm Input port just chosen.

Select the related IP Camera from the “Authentication Camera” pull-down selection (Camera 2 or Channel 2 in this example), also select related “Open Door Port” from the pull-down selection. (Alarm\_Out port 2 in this example).

Make sure the related Open Door Port has physical connection or circuit to the door strike.

Fill in correctly the **digit key** to open door, and the Alarm Duration which is the timer the Alarm\_Out port will send signal to relay to restore the state (10 seconds in the example).

### **NOTE:**

- Enter “#” key following the digits key to execute the operation.

• **Hardware Wiring**

Below are illustration of wiring diagram for the GVR355X.

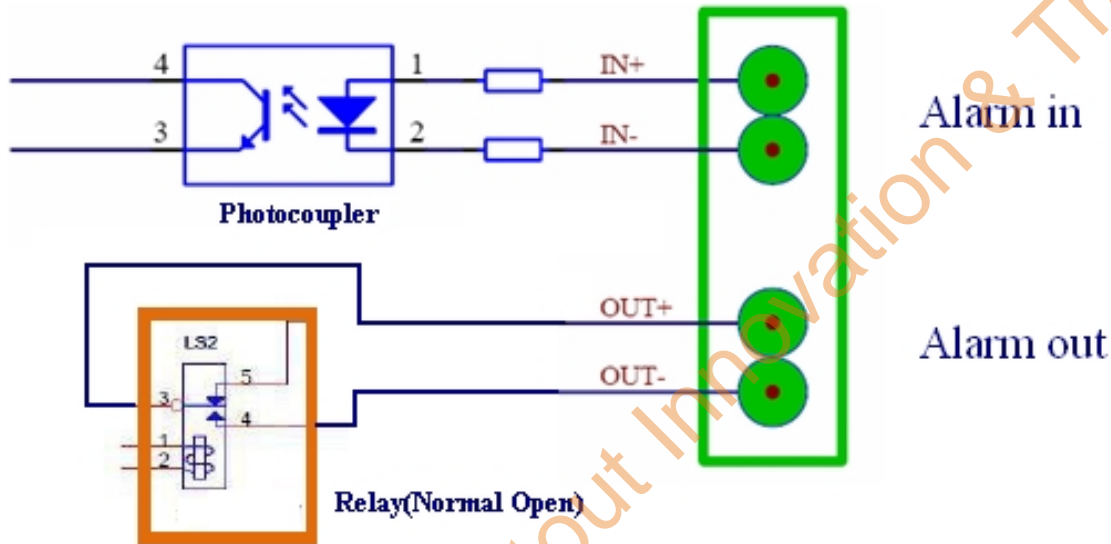

Figure 25-2: Alarm\_In and Alarm\_Out Connection Circuit Sample for GVR355X

**NOTE:**

- The Alarm\_In and Alarm\_Out circuit connection has to be similar to above circuit diagram and meet following requirement:

<b>Alarm Input</b>	Vin<15V, PINs (1.02KΩ)
<b>Alarm Output</b>	125VAC/0.5A, 30VDC/2A, Normal Open, PINs

- The Alarm\_In circuit (like above photo coupler), if there is any voltage change smaller than 15V, as specification listed), the GVR355X Alarm\_In port will detect it and trigger the action and event
- The minimum duration is 500ms for the Alarm\_In to trigger and the minimum voltage change should be bigger than 3V.
- Higher voltage and wrong polarity connection are prohibited because this will damage the devices. So please wiring correctly and do NOT connect the polarity wrong.
- Any Door Bell circuit should be able to connected as Alarm\_In, just make sure the polarity connected correctly and make sure the voltage change meets the requirement.

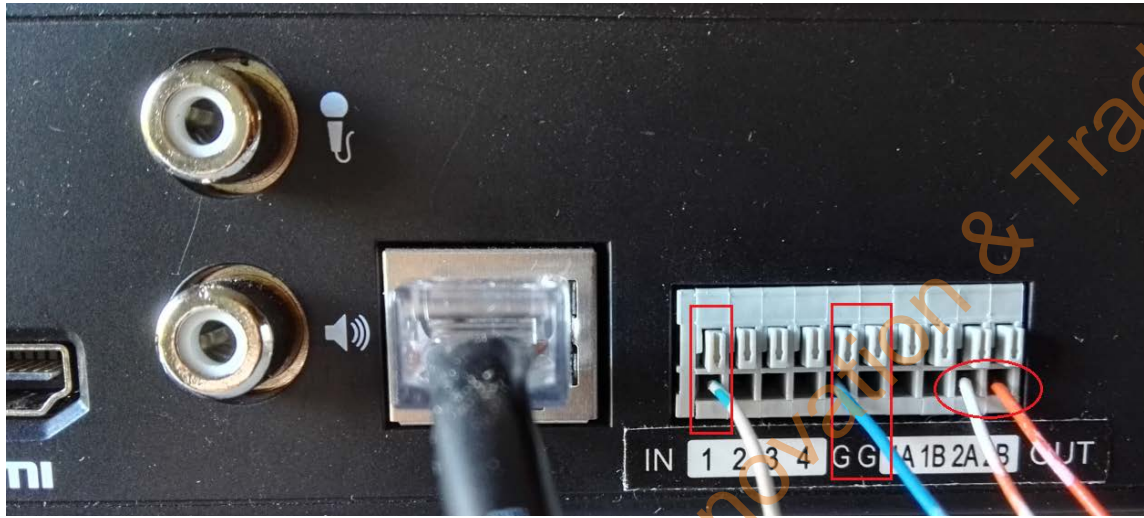

**Figure 25-3: Alarm\_In and Alarm\_Out Wiring Diagram for GVR355X**

**NOTE:**

- Alarm\_In will share the “G” as Ground, make sure to connect the “Negative” or “-“ cable into the interface marked with “G”.
- Alarm\_Out port marked with A, B, please make sure to connect “Positive” or “+” cable into the port with “A”, the “Negative” or “-“ cable into the port with “B”. (In the example, Port 2 configured as Alarm\_Out operation to Open Door, see the cable connected into the GVR3552).

Alarm\_Out duration in the above example is configured as “10 seconds” at the GVR355X. So the Alarm\_Out will act for 10 seconds before revert back to previous state. In the example, the default is circuit “Open”, when Alarm\_Out triggered, the circuit state changed to “Close”, as illustrated below for 10 seconds and then switch back to previous “Open” state.

If connecting to a multi-meter, you will see the Ohm changed from unlimited to several hundred Ohms during the Alarm\_Out port action. See below Figure 8.

Also a “click” audible relay switching sound can be heard if closing enough to the GVR355X when the inside circuit doing the job.



Figure 25-4: GVR355X Alarm\_Out Circuit Measurement

Please contact Grandstream technical support if followed the above instructions but the feature still not working as expected. Please make sure the SIP Proxy or IP-PBX indeed have the related IP Camera and IP Video Phone registered.

## Syslog Settings Page (Troubleshooting Help)

This page allows user to enable the Syslog to help troubleshooting problems:

Figure 26: Alarm Server Setting Page

- **Syslog Server:** Syslog server IP or Domain Name
- **Syslog Lever:** Lever of syslog message sent to the syslog server:  
*None, Debug, Info, Warning, Error.*

## Software Upgrade

This page allows user to configure firmware upgrade.

Software upgrade can be done via TFTP, HTTP or HTTPS. The corresponding configuration settings are in the ADVANCED SETTINGS configuration page.

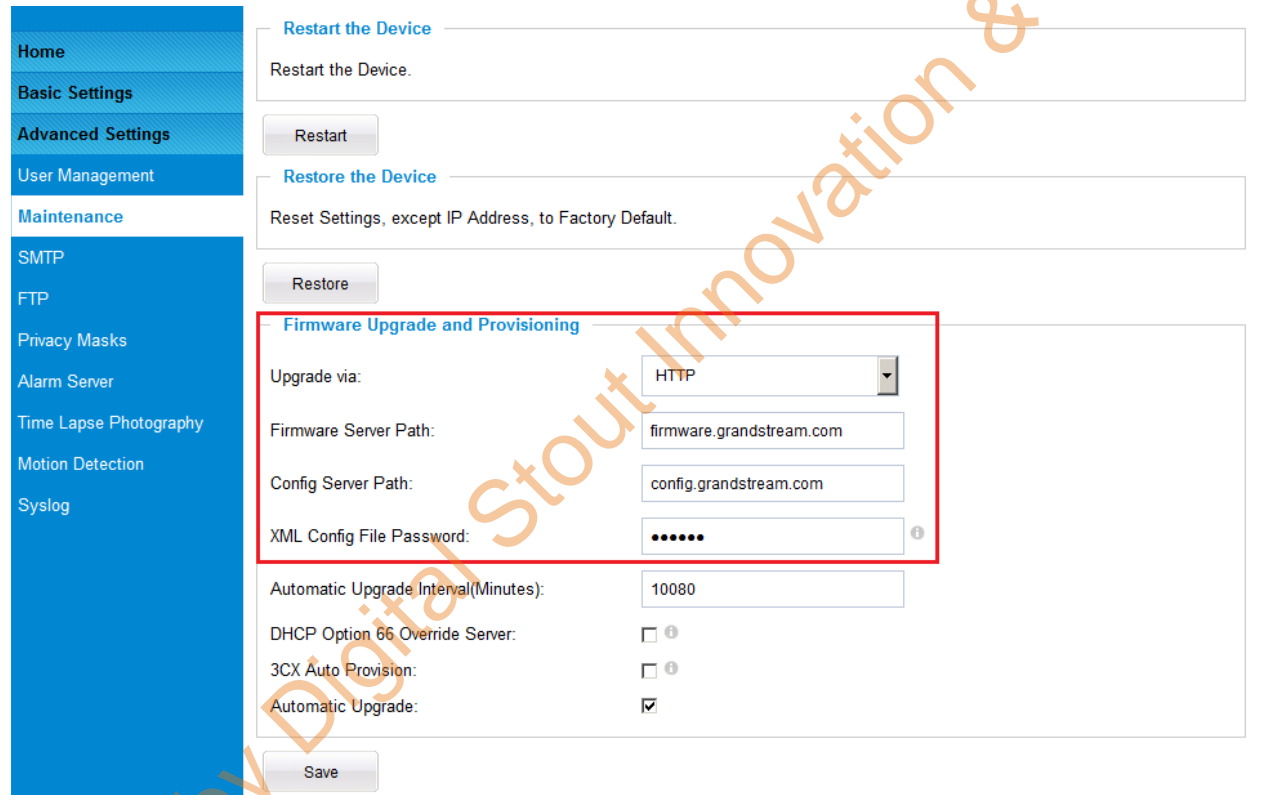

**Figure 27: Firmware Upgrade and Provisioning**

**NOTE:**

- *Grandstream recommends end-user use the Grandstream HTTP server: **firmware.grandstream.com***
- *For large companies, we recommend to maintain their own TFTP/HTTP/HTTPS server for upgrade and provisioning procedures.*

### Instructions for local firmware upgrade using TFTP server:

1. Unzip the file and put all of them under the root directory of the TFTP server.
2. Load the TFTP server from the PC and make sure the device in the same LAN segment.
3. Please go to File -> Configure -> Security to change the TFTP server's default setting from "Receive Only" to "Transmit Only" for the firmware upgrade.
4. Start the TFTP server.
5. In webGUI of IP camera, configure the Firmware Server Path with the IP address of the PC.
6. Update the change and reboot the unit

End users can also choose to download the free HTTP server from <http://httpd.apache.org/> or use Microsoft IIS web server.

### Configuration File Download

Grandstream SIP Device can be configured via Web Interface as well as via Configuration File through TFTP or HTTP/HTTPS. "Config Server Path" is the TFTP or HTTP/HTTPS server path for configuration file. It needs to be set to a valid URL, either in FQDN or IP address format. The "Config Server Path" can be same or different from the "Firmware Server Path".

A configuration parameter is associated with each particular field in the web configuration page. A parameter consists of a Capital letter P and 1 to 3 (Could be extended to 4 in the future) digit numeric numbers. i.e., P2 is associated with "Admin Password" in the ADVANCED SETTINGS page. For a detailed parameter list, please refer to the corresponding firmware release configuration template.

When Grandstream Device boots up or reboots, it will issue request for configuration file named "cfgxxxxxxxxxxxx.xml", where "xxxxxxxxxxxx" is the MAC address of the device, i.e., "cfg000b820102ab.xml". The configuration file name should be in lower cases.

**Currently GXV3672\_HD/FHD v2 only support XML configuration.**

## RESTORE FACTORY DEFAULT SETTING

### WARNING!

Restoring the Factory Default Setting will DELETE all configuration information of the camera. Please BACKUP or PRINT out all the settings before approach to following steps. Grandstream will not take any responsibility if you lose all the parameters of setting or cannot connect to your VoIP service provider.

### Reset from Web Interface

This page allows user to configure dynamic network related parameters:

The screenshot shows the Grandstream web interface. On the left is a blue sidebar menu with the following items: Home, Basic Settings, Advanced Settings, User Management, Maintenance, SMTP, FTP, Privacy Masks, Alarm Server, Time Lapse Photography, Motion Detection, and Syslog. The main content area is divided into three sections:

- Restart the Device:** Contains the text "Restart the Device." and a "Restart" button.
- Restore the Device:** This section is highlighted with a red box. It contains the text "Reset Settings, except IP Address, to Factory Default." and a "Restore" button.
- Firmware Upgrade and Provisioning:** Contains several configuration fields:
  - Upgrade via: HTTP (dropdown menu)
  - Firmware Server Path: firmware.grandstream.com
  - Config Server Path: config.grandstream.com
  - XML Config File Password: [masked with dots]
  - Automatic Upgrade Interval(Minutes): 10080
  - DHCP Option 66 Override Server:  [info icon]
  - 3CX Auto Provision:  [info icon]
  - Automatic Upgrade:

Figure 28: Factory Reset from Web Interface



## IP SURVEILLANCE FAQ

### **1. What is the default IP address of the GXV3672\_HD/FHD v2?**

The default IP configuration is DHCP or 192.168.1.168 after booting up 5 minutes.

### **2. Why can I not view the live video stream in Microsoft Internet Explorer?**

Please double check whether the Grandstream Plug-in/Active-X is installed correctly.

Once you log into the GXV3672\_HD/FHD v2 web interface, Internet Explorer will indicate that this website wants to install the following add-on: "GSViewer.cab" from Grandstream Networks, Inc. Please install this add-on when prompted by IE.

### **3. How do you manually uninstall the Grandstream video viewer add-on for IE?**

Please follow these steps to uninstall the add-on:

1. Delete the *GSViewerX Control* from *C:\WINDOWS\Downloaded Program Files* directory
2. Delete *GSNetClient.dll*, *GS\_Replay.exe*, *GSViewerX.ocx*, *hi\_h264dec\_w.dll*, *lik\_VoiceEngine\_dll.dll* and *GSViewerX.inf* from *C:\WINDOWS\system32*

### **4. Why can't I access the GXV3672\_HD/FHD v2 web configuration interface?**

Q 1: Is your internet service down?

A 1: Connect a PC to the internet to test the connection.

Q 2: Are the PC and the device in different subnets?

A 2: Check the subnet mask and default gateway of the device and PC.

Q 3: Is there a conflict with another IP address?

A 3: Try to change the IP address of the device.

Q 4: Has the HTTP port been changed?

A 4: Contact the administrator of the device for more information.

### **5. The GXV3672\_HD/FHD v2 web configuration page is not displayed correctly in IE8 ?**

In IE8, Compatibility View might need to be enabled for the GXV3672\_HD/FHD v2 web configuration page to load properly. To enable compatibility view, open IE8, click *Tools, Compatibility View Setting*, and add the GXV3672\_HD/FHD v2 web configuration pages to the Compatibility View.

### **6. Why does IE indicate to install Grandstream Video Viewer add-on after a firmware upgrade? The add-on was properly installed before the firmware upgrade process.**

New firmware will often upgrade the add-on as well. To watch the live video stream, you must install the newest version of the add-on.

### **7. How do you watch secondary video stream?**

Login to the home page of the GXV3672\_HD/FHD v2 web GUI, click Play to watch the video stream. To watch a secondary video stream, right click on the video, and select *Secondary Stream* on the pop-up menu. Try reinstalling the Grandstream Viewer add-on for IE if you cannot see the video stream.

### **8. What is DDNS? Is it important for IP surveillance product to have DDNS support?**

DDNS is an acronym for Dynamic Domain Name Service. It is important to choose an IP network camera that has DDNS support for dynamic IP addresses. Chances are that the network has a dynamic IP address (which changes with every log on). A DDNS service makes sure that the camera's IP address always matches up to the current server address. DDNS also allows a website to be linked to the IP camera that is constantly updated with the correct information and has a reliable feed.

### **9. Why is Windows Media Player unable to play the recorded video files?**

The GXV3672\_HD/FHD v2 uses the H.264 video codec. Windows Media Player may lack the proper H.264 decoder to play the recorded video. Please download the Microsoft FFDSHOW H.264 decoder from <http://sourceforge.net/projects/ffdshow-tryout/> and install it.

### **10. Alarm Triggered Events do not work with GSurf\_Pro?**

Please double check the Alarm Action on your GXV3672\_HD/FHD v2. Login to the web GUI of the GXV3672\_HD/FHD v2, go to the Motion Detection or Alarm Events page, and make sure option Upload to Alarm Center is checked.

### **11. Recommended to save the video files in different directories when using GSurf\_Pro?**

It is better to save video files in different directory to prevent accidental deletion of the recorded files you need.

### **12. How to use a cell phone to watch the GXV3672\_HD/FHD v2 video stream?**

You must set the video resolution to QCIF to watch the GXV3672\_HD/FHD v2 video stream from a cell phone. Make sure to set the bit rate to 64kbps to ensure the best video quality.

### **13. What Smartphone application should I use to view the video?**

There are free applications and paid version application for this, you can find them in Google Play for Android phone and Apple Store for iPhone, like: IP Cam Viewer:



<http://hit-mob.com/>

**14. Why the IP address of the device NOT reset when clicking the “Restore” button?**

The GXV3672\_HD/FHD v2 could be installed in areas that are not easy to access. For example, it could be installed on the roof of a building or the ceiling of an office. This makes it difficult to reinstall the device, therefore the “Restore” function will not clear the IP address.

**15. Why can't the live video stream be viewed using a mobile phone or GSurf\_Pro after changing the HTTP Port of the device?**

Make sure that the RTSP port of the device is set to 2000 plus the HTTP Port number. For example, if the HTTP port is 88, then the RTSP port of the device that you configured on GSurf\_Pro or mobile phone should be 2088.

**16. Port forwarding**

Two ports must be forwarded on your router to watch video from a GXV3672\_HD/FHD v2 that is located on a private network from a PC in a public network. The web port (HTTP) and the RTSP port. Please make note that the RTSP port number changes according to the web port. If the web port is 80, then the RTSP port is 554. If the web port is not 80, then the RTSP port equals the web port +2000. For example, if the web port is 88, then the RTSP port will be 2088.